

Quick Installation Guide

X1-Matebox advanced



1. Introduction

X1-Matebox is a critical part for Solax AC in one energy storage system, which integrates the AC breaker/switch unit/CT and so on. It can easily be installed compared to the traditional separate system. This unit can be used with Solax X1-Hybrid G4 and X1-Fit G4 series inverters.

There are 2 wiring diagrams for your system connection reference, please follow your local policy to choose which one is suitable for your side.

Diagram A: Neutral line and PE line are separated from each other, all loads connect to the EPS (Off-grid) port;

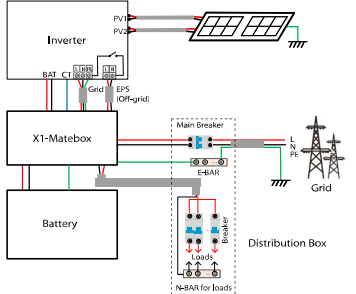
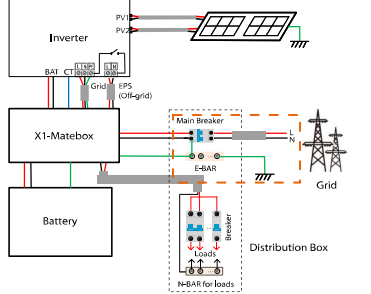
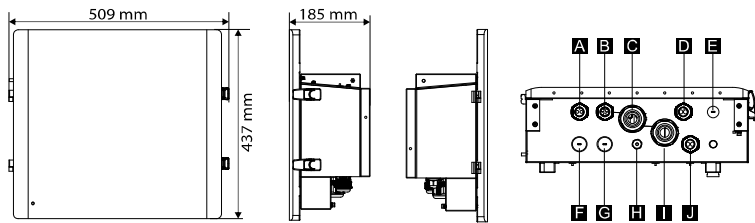

Diagram B: Neutral line and PE line are combined together, all loads connect to the EPS (Off-grid) port.



2. Overview



Object	Name	Description
A	EPS (Off-grid)1	EPS (Off-grid)1 output port of the inverter
B	Grid1	Grid1 output port of the inverter
C	Grid	Grid connection port (to local grid)
D	BAT	Battery connection port (to battery pack)
E	CAN	Reserved
F	EPS (Off-grid)2	Reserved
G	Grid2	Reserved
H	CT	CT connection port of the inverter
I	Load	Load connection port
J	BAT(INV)	Battery connection port of the inverter

3. Preparation

3.1 Check Packing List

Open the package and check the materials and accessories according to the following list.

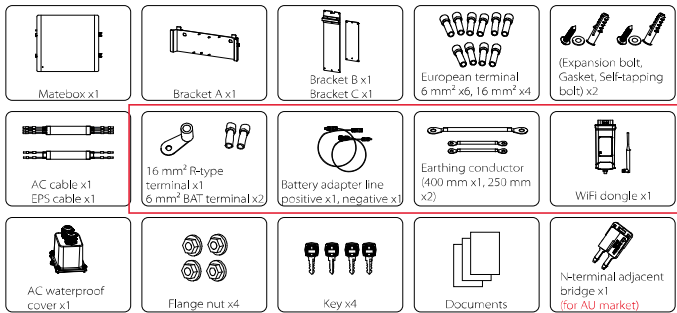

3.2 Tools



4. Mounting

The bracket of the matebox is composed of three parts. Bracket A is used to install the matebox. Bracket B is used to fix the bracket position of the inverter, and Bracket C is used to fix the bracket position of the battery.

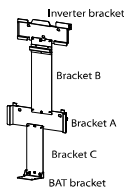

Step 1: Connect all brackets

First of all, connect inverter bracket, Bracket B, Bracket A, Bracket C and BAT bracket all together with flange nuts.

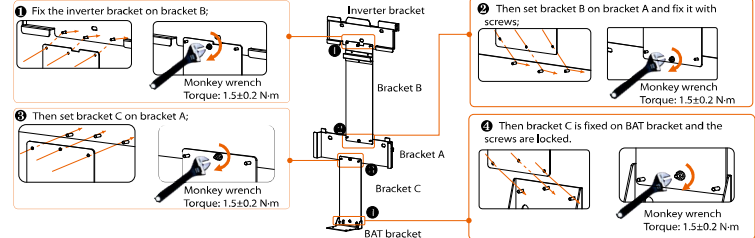

Step 2: Connect the BAT bracket and battery and push the whole structure to the wall

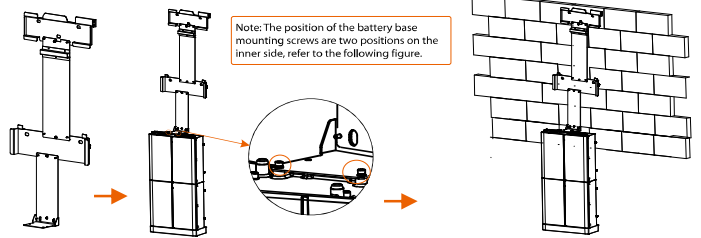

Step 3: Fix the position, drill holes and install the whole structure on the wall

a) With the position of the brackets as a template in step 2, use a spirit level to mark the holes needed on the wall with a marker pen.

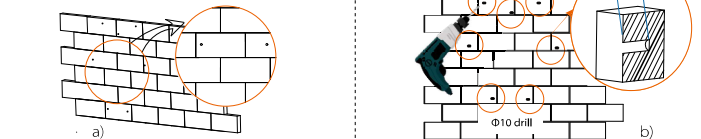

c) Insert expansion bolts into the holes, use rubber hammer to knock the expansion bolts into the wall.

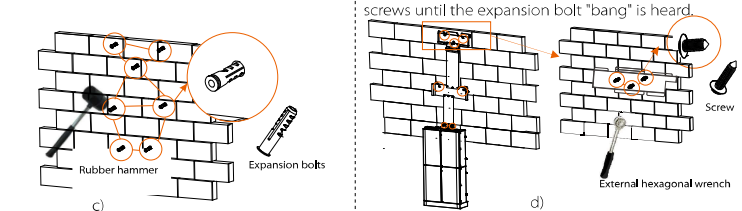

Step 4: Install inverter

Make sure all brackets (bracket A, bracket B, bracket C, inverter bracket and BAT bracket) are well and firmly installed.

a) Take the AC waterproof cover from the matebox (instead of the one from D version inverter) and connect the AC cable and EPS cable through the AC waterproof cover to the inverter. (For details, please refer to the documents of the inverter.)



c) Use the inner hexagonal wrench to tighten the inner hexagonal screw on the right side of the inverter.

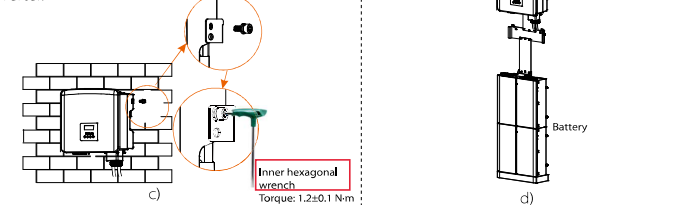

Step 5: Install matebox

a) Cut off the strips of the box except the strips on the back of the box before installing the box. Open the unlocked buckle of the matebox, open the upper cover and remove the protective cover; (open the button by hand, open the cover and slide upwards.)

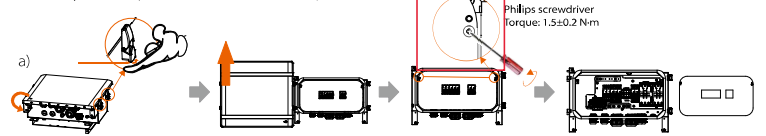

b) Put the matebox on the bracket. Make sure the box is well fixed on the bracket by screwing all nuts tightly.

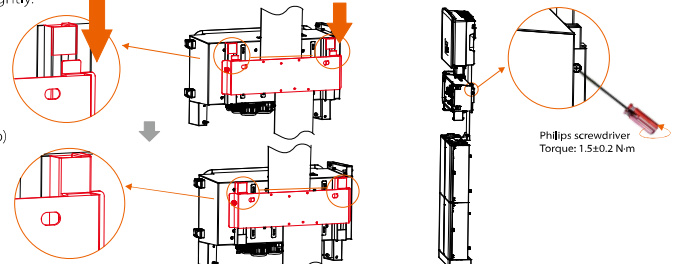

5. Monitoring Connection

- Insert the WiFi dongle into the Dongle port of the inverter.
- Take out the antenna from the box of monitoring accessories and install the antenna on bracket A and tighten it by hand.
- Then connect the antenna cable to the end of the WiFi dongle.

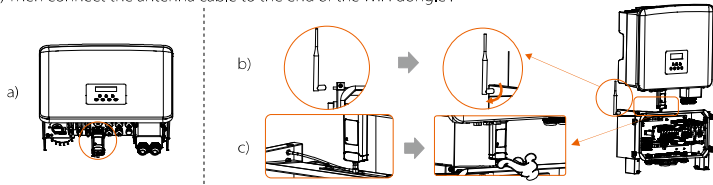

6. Wiring Connection

6.1 Inverter side connection

- According to the BAT(INV)+ / BAT(INV)- line symbol on the matebox, insert the lines into the corresponding BAT+ / BAT- ports of the inverter.
- Connect the CT cable of the matebox to the CT port of the inverter, and tighten the waterproof plug.

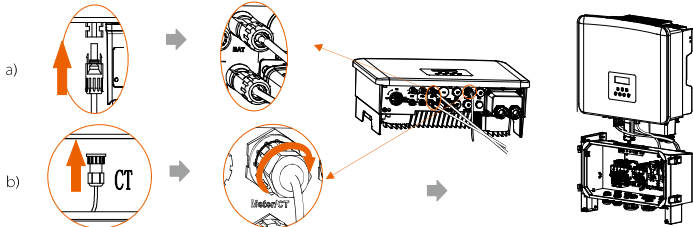

6.2 Matebox side connection

1) Open the protective cover. Connect the Grid1 L/N and EPS (Off-grid)1 L/N/PE lines between the inverter and the matebox. The connection method is as follows:

- First, insert Grid1 L/N and EPS (Off-grid)1 L/N into the matebox port firmly, and then gently pull to check if they are connected properly and screw the waterproof plug tightly;
- Connect the Grid (PE), use a philips screwdriver to tighten the screws.

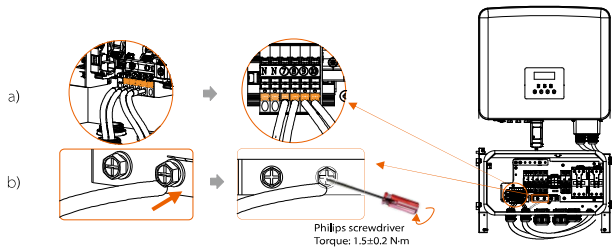

2) Grid(L/N/PE) /Load(L/N) side connection.

- Grid(L/N/PE) /Load(L/N) wire, remove the 12 mm insulation layer at the end of the wire. Insert the European terminals respectively. The stripped terminals must be inserted into the European terminals and finally pressed down with the crimping pliers.

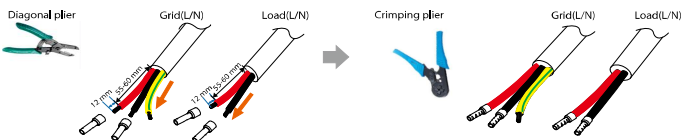

- Grid(PE) strip the grounding cable, remove the 13 mm insulation layer at the end of the wire. Insert the stripped cable into the R-type terminal, and then clamp it.

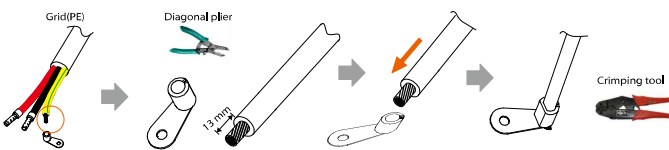

- Pass the Grid/Load line through the Grid/Load port of the matebox, then find the Grid (L/N) and Load (L/N) ports in the matebox, insert each line accordingly, and use the screwdriver to lock the screws. Grid (PE) is secured with a philips screwdriver.

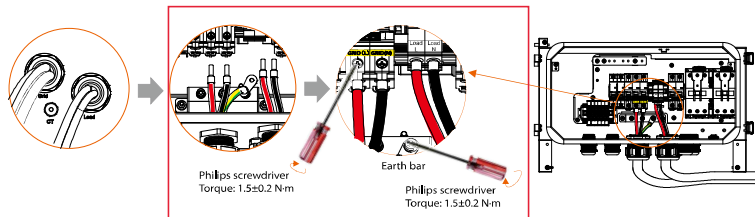

- Take out the power cable from the BMS accessories, and cut it to 560-600 mm and strip 7 mm of the insulation layer from the wire ends. Crimp the 6 mm² BAT terminals on the wires. Then pass the cable through the BAT port of the matebox, then find the BAT+ and BAT- ports in the matebox, insert each wire accordingly, and use the philips screwdriver to lock the screws.

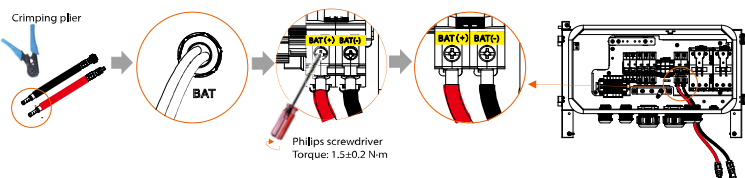

6.3 Ground wire connections

There are three parts that need to be grounded, one is between the inverter and the matebox, one between the matebox and the battery and the other between the upper cover and the matebox.

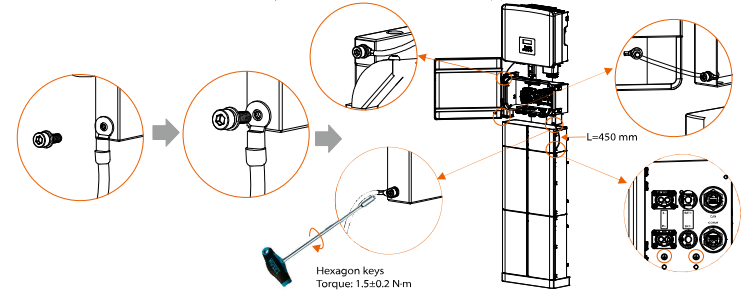

6.4 Battery's communication wire connection

-When the distance between the matebox and the battery is < 1 m, you can use the BMS communication line in the accessory bag.

-When the distance between the matebox and the battery is > 1 m, you need to prepare the regular network cable and find the RJ45 terminal of the accessory package to make the cable.

The BMS port connection between the inverter and the battery (for the specific connection method, please refer to the inverter and battery quick installation guide):

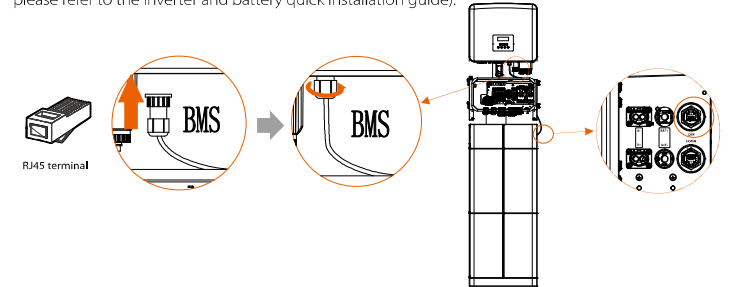

6.5 N lines short circuit (applicable in Australia)

- According to local regulations, the continuity of the neutral line of EPS load and that of the grid is not interrupted when the inverter disconnects from the grid (for wiring Australia and New Zealand regulations AS/ NZ_s_3000:2012).

- First, find N-terminal adjacent Bridge in the accessory package.

- Forcibly insert N-terminal adjacent bridge into the N-terminal hole and jam it. Twist gently and make sure it would not become loose.

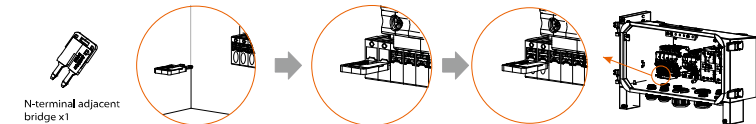

6.6 Finally, use a philips screwdriver to install the baffle back, install the upper cover, and then lock the buckle with a key

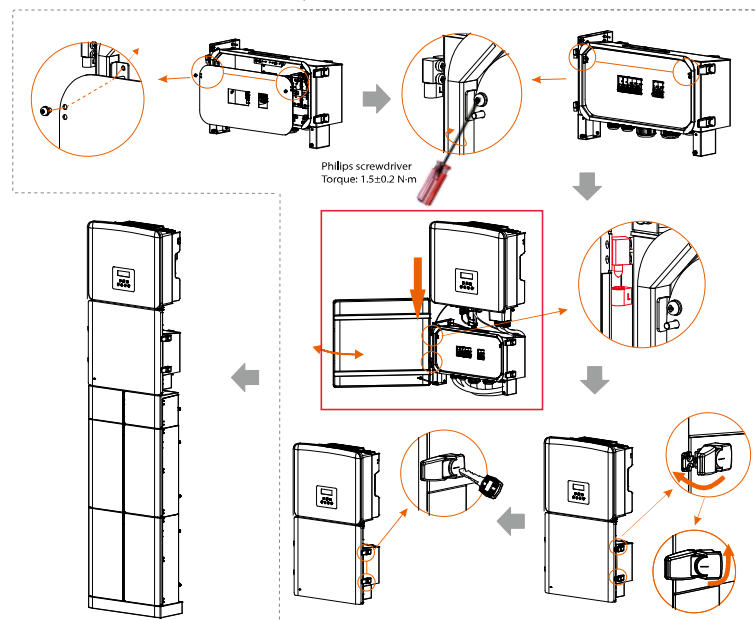

7. Technical Parameters

DC Input/Output	
Battery Voltage Range	80-480 V d.c.
Max. Charge/Discharge Current	30 A/30 A
Grid Input/Output	
Rated Grid Voltage, Frequency	220/230/240 V a.c., 50/60 Hz
Max. Grid Input Current	60 A
Max. Apparent Grid (INV) Input Power	7500 VA
Max. Apparent Grid (INV) Output Power	7500 VA
Load	
Rated Grid Voltage, Frequency	220/230/240 V a.c., 50/60 Hz
Max. Load Current	60 A
Max. Apparent EPS Output Power	7500 VA
Installation Specification	
Dimension (L*W*H)	185 mm * 509 mm * 437 mm
Weight	10 kg
Operating Temperature	-35°C~+60°C
Installation	Wall Mounted