



X1/X3-EVC

User Manual

X1-EVC-7.2K(SXC) / X3-EVC-11K(SXC) / X3-EVC-22K(SXC)
X1-EVC-7.2K(PXC) / X3-EVC-11K(PXC) / X3-EVC-22K(PXC)
X1-EVC-7.2K(SLC) / X3-EVC-11K(SLC) / X3-EVC-22K(SLC)
X1-EVC-7.2K(PLC) / X3-EVC-11K(PLC) / X3-EVC-22K(PLC)
X1-EVC-7.2K(SXC)-P / X1-EVC-7.2K(PXC)-P
X3-EVC-11K(SXC)-P / X3-EVC-11K(PXC)-P
X3-EVC-22K(SXC)-P / X3-EVC-22K(PXC)-P



eManual in the QR code or at
[https://kb.solaxpower.com/
Download.html](https://kb.solaxpower.com/Download.html)

www.solaxpower.com

STATEMENT

Copyright

Copyright © SolaX Power Technology (Zhejiang) Co., Ltd. All rights reserved.

No part of this manual may be reproduced, transmitted, transcribed, stored in a retrieval system, or translated into any language or computer language, in any form or by any means without the prior written permission of SolaX Power Technology (Zhejiang) Co., Ltd.

Trademarks



SOLA X and other symbol or design (brand name, logo) that distinguishes the products or services offered by SolaX has been trademark protected. Any unauthorized use of above stated trademark may infringe the trademark right.

Notice

Please note that certain products, features, and services mentioned in this document may not be within the scope of your purchase or usage. Unless otherwise specified in the contract, the contents, information, and recommendations presented in this document are provided "as is" by SolaX. We do not provide any warranties, guarantees, or representations, whether express or implied.

Note that the content of the documents is regularly reviewed and updated as needed. However, occasional discrepancies may occur. SolaX retains the right to enhance or modify the product(s) and program(s) described in this manual without prior notice.

The images included in this document are solely for illustrative purposes and may differ based on the specific product models.

For more detailed information, kindly visit the website of SolaX Power Technology (Zhejiang) Co., Ltd. at www.solaxpower.com.

SolaX retains all rights for the final explanation.

About This Manual

Scope of Validity

This manual is an integral part of X1/X3-EVC Series EV-Charger. It describes the installation, electrical connection, commissioning, maintenance and troubleshooting of the product. Please read it carefully before operating.

X1-EVC-7.2K(SXC)	X1-EVC-7.2K(PXC)
X3-EVC-11K(SXC)	X3-EVC-11K(PXC)
X3-EVC-22K(SXC)	X3-EVC-22K(PXC)
X1-EVC-7.2K(SLC)	X1-EVC-7.2K(PLC)
X3-EVC-11K(SLC)	X3-EVC-11K(PLC)
X3-EVC-22K(SLC)	X3-EVC-22K(PLC)
X1-EVC-7.2K(SXC)-P	X1-EVC-7.2K(PXC)-P
X3-EVC-11K(SXC)-P	X3-EVC-11K(PXC)-P
X3-EVC-22K(SXC)-P	X3-EVC-22K(PXC)-P

Note:

"X1" means single-phase, "X3" means three-phase.

"EVC" means "EV-Charger".

"7.2K" means that the nominal output power is 7.2 kW, so does for "11K" and "22K".

"S" means Socket Type, only socket outlet, "P" means Plug Type (also called Connector Type), with charging cable and connector.

"X" means without LCD screen, "L" means with LCD screen.

"C" means commercial edition.

"-P" means with PEN protection function.





Target Group

The installation, maintenance and grid-related setting can only be performed by qualified personnel who

- Are licensed and/or satisfy state and local jurisdiction regulations.
- Have good knowledge of this manual and other related documents.

Conventions

The symbols that may be found in this manual are defined as follows.

Symbol	Description
 DANGER	Indicates a hazardous situation which, if not avoided, will result in death or serious injury.
 WARNING	Indicates a hazardous situation which, if not avoided, could result in death or serious injury.
 CAUTION!	Indicates a hazardous situation which, if not avoided, could result in minor or moderate injury.
 NOTICE!	Provides tips for the optimal operation of the product.

Change History

Version 01 (2023-08-18)

Added models with screen and all related contents, including discriptions about screen

Added white inverter connector and updated contents about connecting inverter

Updated the figures and contents due to RS485 change of the EV-Charger

Version 00 (2023-05-29)

Initial release

Table of Contents

1	Safety	1
1.1	General Safety	1
1.2	Safety Instructions	1
2	Product Overview	3
2.1	System Description	3
2.2	Supported Power Grid	3
2.3	Appearance	4
2.3.1	Dimensions	6
2.3.2	LCD Panel	7
2.3.3	Symbols on the Label	8
2.4	Principle Circuit Diagram	9
2.5	Basic Features	10
3	Transportation and Storage	11
4	Preparation before Installation	12
4.1	Selection of Installation Location	12
4.1.1	Environment Requirement	12
4.1.2	Installation Carrier Requirement	13
4.1.3	Clearance Requirement	13
4.2	Tools Requirement	14
4.3	Additionally Required Materials	15
5	Unpacking and Inspection	16
5.1	Unpacking	16
5.2	Scope of Delivery	17
6	Installation and Wiring	18
6.1	Decide Application Scenario	19
6.2	Installation and Wiring Steps	22
7	Power on	36
7.1	Checking before Powering on	36
7.2	Powering on	36
8	App Setting	37
8.1	Download, Registration and Login	37
8.1.1	Downloading and installing App	37

8.1.2	App Registration and Login	38
8.2	Configuration.....	41
8.2.1	Add Device	41
8.2.2	Wi-Fi Connection.....	41
8.2.3	Local Mode	43
8.3	Settings for EV-Charger	44
8.3.1	Operation to Enter the Setting Page	44
8.3.2	Overview of the Setting Page.....	47
9	Operation Method	49
9.1	States	49
9.2	Start-up Patterns	49
9.3	Application Scene Setting	50
9.4	RFID Function Operation	52
9.5	Detailed Function Operation.....	53
9.5.1	Charging modes in Home Scene.....	53
9.5.2	Boost Settings in Home Scene	56
9.5.3	Dynamic Load Balance.....	59
9.5.4	Modbus Setting.....	60
9.5.5	Charging Restrict.....	61
9.5.6	Random Charging Delay.....	63
9.5.7	Three Phase Imbalance.....	63
10	Screen Display	64
10.1	Description of Icons on the Screen	64
10.2	Description of Status Screen	66
11	Troubleshooting and Maintenance	71
11.1	Power off.....	71
11.2	Troubleshooting.....	71
11.3	Maintenance.....	74
12	Decommissioning.....	75
12.1	Disassembling the EV-Charger	75
12.2	Packing the EV-Charger	75
12.3	Disposing of the EV-Charger	75
13	Technical Data	76

1 Safety

1.1 General Safety

The series EV-Charger has been meticulously designed and thoroughly tested to comply with all relevant state and international safety standards. Nevertheless, like all electrical and electronic equipment, safety precautions must be observed and followed during the installation of the EV-Charger to minimize the risk of personal injury and ensure a safe installation.

Please thoroughly read, comprehend, and strictly adhere to the comprehensive instructions provided in the user manual and any other relevant regulations prior to the installation of the EV-Charger. The safety instructions in this document serve as supplementary guidelines to local laws and regulations.

SolaX shall not be liable for any consequences resulting from the violation of the storage, transportation, installation, and operation regulations outlined in this document. Such consequences include, but are not limited to:

- EV-Charger damage caused by force majeure events, such as earthquakes, floods, thunderstorms, lightning, fire hazards, volcanic eruptions, and similar events.
- EV-Charger damage due to human causes.
- Usage or operation of the EV-Charger in violation of local policies or regulations.
- Failure to comply with the operation instructions and safety precautions provided with the product and in this document.
- Improper installation or usage of the EV-Charger in unsuitable environmental or electrical conditions.
- Unauthorized modifications made to the product or its software.
- EV-Charger damage occurring during transportation by the customer.
- Storage conditions that do not meet the requirements specified in this document.
- Installation and commissioning performed by unauthorized personnel who lack the necessary licenses or do not comply with state and local jurisdiction regulations.

1.2 Safety Instructions

Save these important safety instructions. Failure to do so may result in damage to the EV-Charger and injury or even loss of life.

 **DANGER!**

- Danger to life due to output and input high voltages in this device.
- Do not attempt to open the enclosure without authorization from SolaX. Unauthorized opening of the enclosure will void the warranty and can result in lethal danger or serious injury due to electric shock.
- Do not use an extension cord on the EV-Charger, or it may cause a risk of fire or electric shock.
- Do not use the EV-Charger if the device has defects, cracks, abrasion, or shows other signs of damage.
- Disconnect the power supply to the EV-Charger before installation, maintenance and other operations.

 **WARNING!**

- Keep away from flammable, explosive materials and humid or corrosive substance.
- The device is intended only for charging electric vehicles. Do not charge other devices.
- In case any emergency condition happens, press the EMERGENCY STOP button immediately, cut off all input and output power supply.
- During charging, the electric vehicle is not allowed to drive. Charging only when the electric vehicle stays still. For hybrid car, charging only when switching the engine off.
- Do not touch live electrical parts of the EV-Charger, especially when during charging.

 **CAUTION!**

- Keep children away from the EV-Charger.
- During operation, the EV-Charger may become hot. There may be burn injuries caused by hot surface.
- Incorrect operation or misuse may result in: Injury or death to the operator or third parties; Damage to the device and other property of the operator; Inefficient operation of the device.

NOTICE!

- All operations shall be in compliance with local laws and regulations.
- Do not use cleaning solvents to clean any part of the EV-Charger. Clean the device with a clean, dry cloth to remove dust and dirt.
- Keep all product labels and the nameplate on the EV-Charger clearly visible and well-maintained.

NOTICE!

- Only connect the EV-Charger to the grid with the permission of the local utility grid company.

2 Product Overview

2.1 System Description

The X1/X3-EVC series are AC EV charger and intended only for charging electric vehicles. It should be installed in a fixed location and connected to the AC supply. The EV-Charger can communicate with other devices or systems (inverter, meter, CT, third-party charger management platform, etc.) to realize intelligent control of charging process. For details, please refer to ["6.1 Decide Application Scenario"](#).

2.2 Supported Power Grid

There are different ways of wiring for different grid systems. Models named without "-P" support TN-S, models named with "-P" support TN-C-S, shown as below:

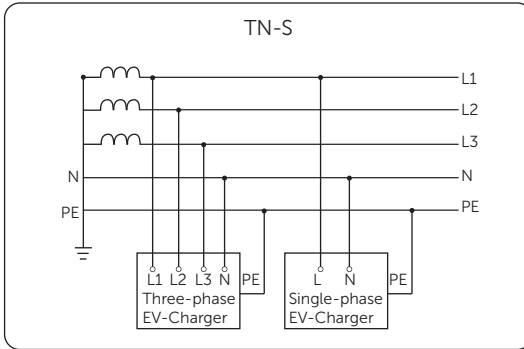

Figure 2-1 Supported power grid for models named without "-P"

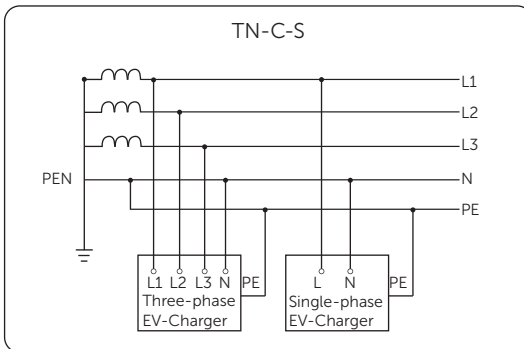

Figure 2-2 Supported power grid for models named with "-P"

2.3 Appearance

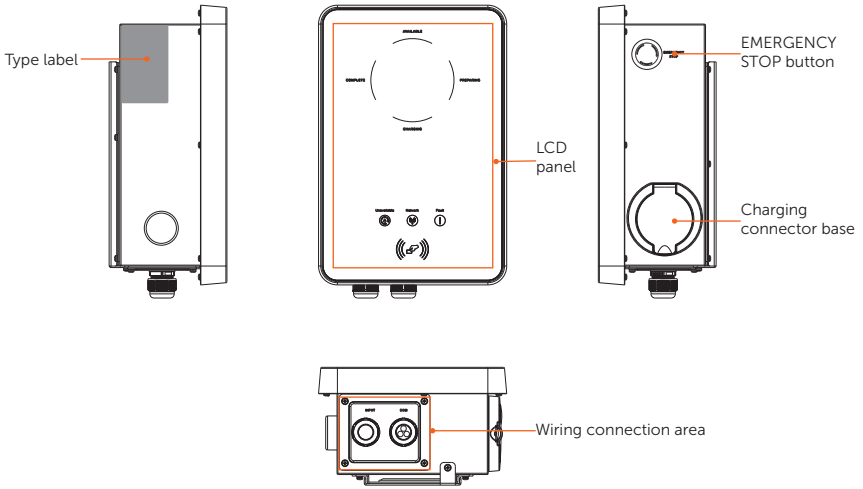

Figure 2-3 Appearance of Socket Type

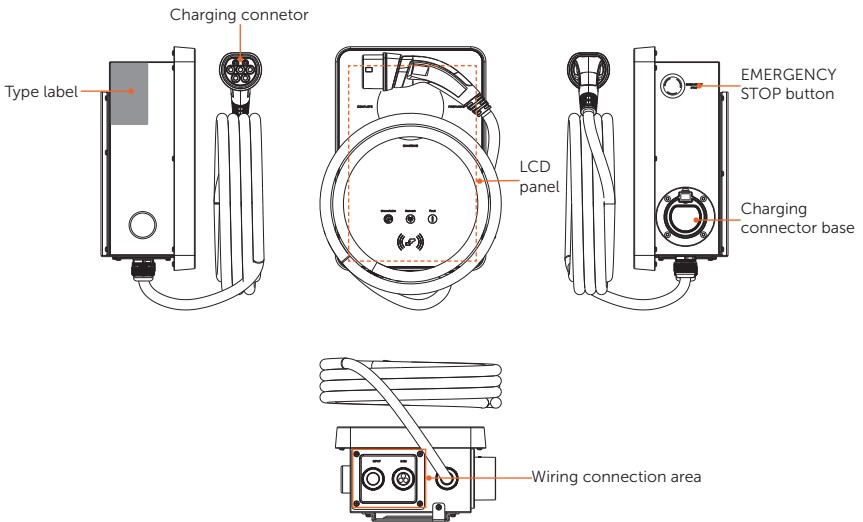

Figure 2-4 Appearance of Plug Type

Table 2-1 Description of appearance

Item	Description
Type label	Type label clearly identifies the device type, serial number, specific parameters, certification, etc.
LCD panel	Including LED indicators, LCD screen (Optional) and card swiping position. LED indicators indicate the operating status of the EV-Charger. LCD screen displays the information. Card swiping position is for swiping RFID card.
EMERGENCY STOP	Press the button in emergency, the EV-Charger will stop charging.
Charging connector base	Socket outlet (for Socket Type) / Connector holder (for Plug Type)
Wiring connection area	Including INPUT port and COM port. INPUT port is for AC input connection and COM port is for communication connection.
Charging connector	Charging connector for connecting EV (Only for Plug Type).

2.3.1 Dimensions

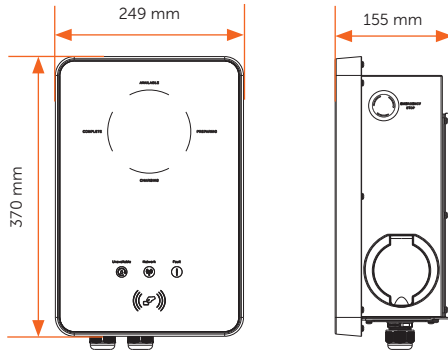

Figure 2-5 Dimensions of Socket Type

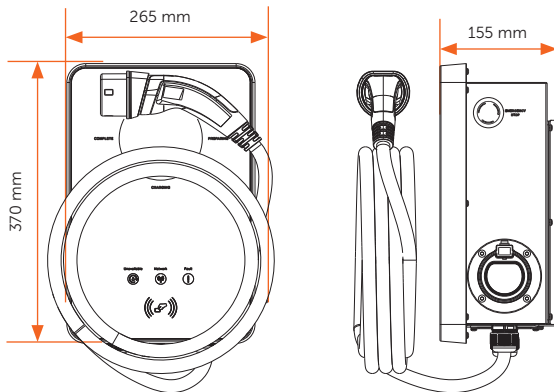

Figure 2-6 Dimensions of Plug Type

2.3.2 LCD Panel

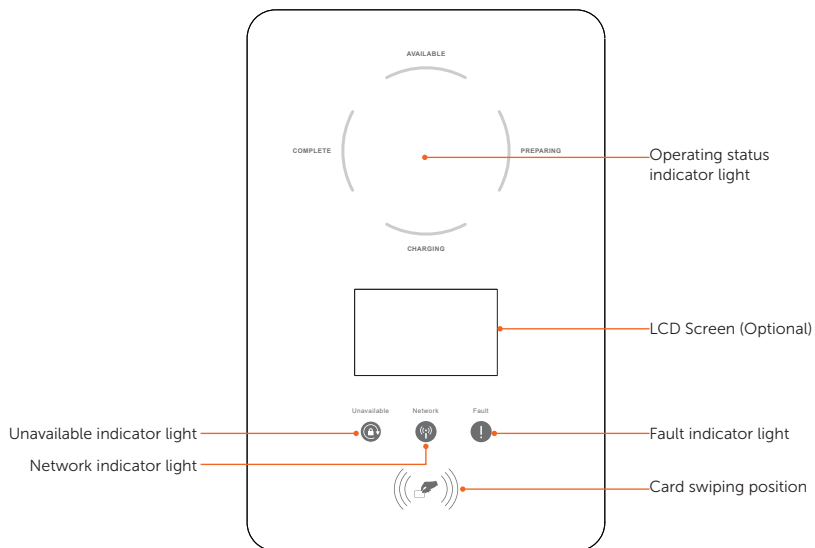

Figure 2-7 LCD Panel







- In a normal state, the "AVAILABLE" light will be blue when the connector is not plugged and the "PREPARING" light will be blue when plugged.
- In an error state, the "Fault" light will be red, please check the fault message on the App and refer to corresponding solutions in "[11.2 Troubleshooting](#)".

Table 2-2 Definition of indicators, screen and card swiping position

Name	Definition
Operating status indicator light	The corresponding status light will be blue when operating.
Unavailable indicator light	Light in blue: The EV-Charger is not available for charging.
Network indicator light	Light in blue: The EV-Charger is connected with network server.
Fault indicator light	Light in red: The EV-Charger is in fault state.
LCD screen (Optional)	The information of the EV-Charger will be displayed. (For details, please refer to " 10 Screen Display ".)
Card swiping position	Swipe RFID card here.

2.3.3 Symbols on the Label

Table 2-3 Description of symbols

Symbol	Description
	CE mark of conformity
	TUV certification
	UKCA mark of conformity
	Caution, risk of electric shock
	Caution, risk of danger
	The EV-Charger can be recycled.
	Do not dispose of the EV-Charger together with household waste. Used electrical devices must be collected separately and recycled in an environmentally responsible manner. Ensure that you return your used device to your dealer or obtain information regarding a local, authorised collection and disposal system.

Note: The table is only used for the description of symbols which may be used on the EV-Charger. Please be subject to the actual symbols on the device.

2.4 Principle Circuit Diagram

The principle design of the EV-Charger is shown in the figure below:

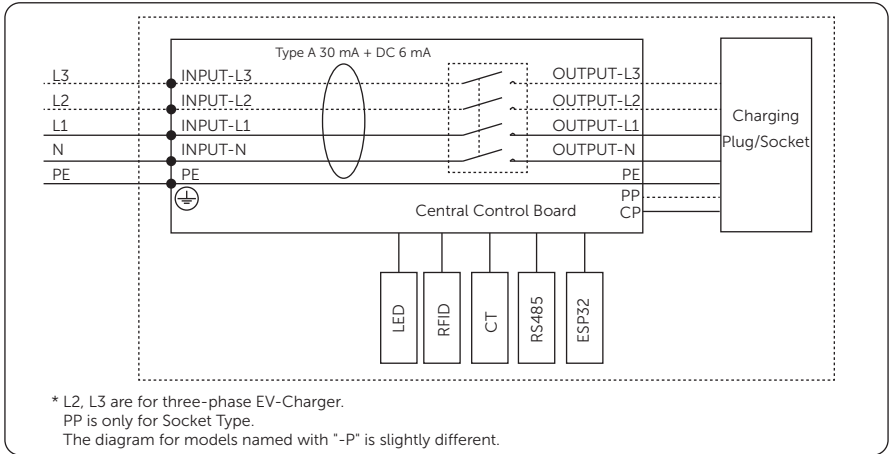

Figure 2-8 Principle Circuit Diagram

2.5 Basic Features

The features of the series EV-Charger are listed as below.

- Plug or socket outlet selectable
- Integrated current failure monitoring (30 mA AC & 6 mA DC)
- Encrypted communication based on TLS
- Indoor and outdoor easy installation
- Form an intelligent photovoltaic, storage and EV charging energy system through the communication between the smart EV charger and SolaX inverter
- Capable with 100% green energy generated from your solar generation
- Multiple work modes to fit different situations
- Integrated RFID function
- Remote setting and monitoring with APP and website
- Smart dynamic load balance control
- Set timers to reduce your cost during peak and valley price
- Integrated with OCPP 1.6(JSON) protocol
- Delayed startup configurable
- Integrated with PEN protection and no earth rod (Only for models named with "-P")

3 Transportation and Storage

If the EV-Charger is not put into use immediately, the transportation and storage requirements needs to be met:

Transportation

- Observe the caution signs on the packaging of EV-Charger before transportation.
- Pay attention to the weight of EV-Charger. Be cautious to avoid injury when carrying the EV-Charger.
- Wear protective gloves when carrying the equipment by hand to prevent injuries.
- When lifting up the EV-Charger, hold the bottom position of the EV-Charger. Keep it horizontal in case of falling down due to tilt.

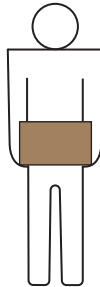

Figure 3-1 Handle position of carton

Storage

- The EV-Charger must be stored indoors.
- Do not remove the original packaging material and check the outer packaging material regularly.
- The storage temperature should be between -30°C and $+60^{\circ}\text{C}$. The humidity should be between 5% and 95%.
- Stack the EV-Charger in accordance with the caution signs on the carton to prevent their falling down and device damage. Do not place it upside down.
- If the EV-Charger has been stored for more than 2 years, it must be checked and tested by professionals before use.

4 Preparation before Installation

4.1 Selection of Installation Location

The installation location selected for the EV-Charger is quite critical in the aspect of the guarantee of device safety, service life and performance.

- It has the IP65 ingress protection, which allows it to be installed outdoor;
- The installation position shall be convenient for wiring connection, operation and maintenance.

4.1.1 Environment Requirement

Make sure the installation site meets the following conditions:

- The ambient temperature: -30°C to +50°C (without screen),
-20°C to +50°C (with screen);
- The humidity shall be between 5-95%;
- Do not install the EV-Charger in the areas where the altitude exceeds 2000 m;
- Install the EV-Charger in a well-ventilated environment for heat dissipation;
- Do not install the EV-Charger in areas with flammable, explosive and corrosive materials;
- Do not install the EV-Charger in areas near combustibles and antenna;
- You are recommended to install an awning over it. Direct sunlight, rain exposure and snow laying up is not allowed.

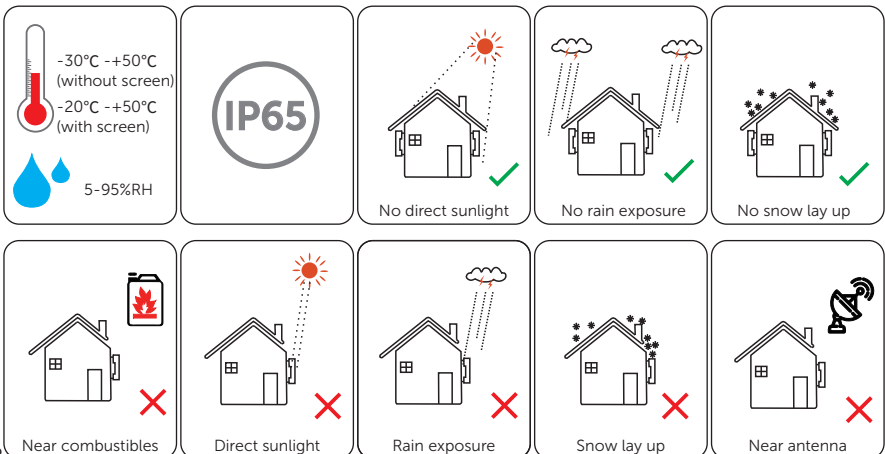

4.1.2 Installation Carrier Requirement

The mounting location must be suitable for the weight and dimensions of the product and the support surface for installation must be made of a non-flammable material.

- Solid brick/concrete, or mounting surface with equivalent strength;
- The EV-Charger must be supported or strengthened if the wall strength is not enough (such as wooden wall, the wall covered by thick layer of decoration).

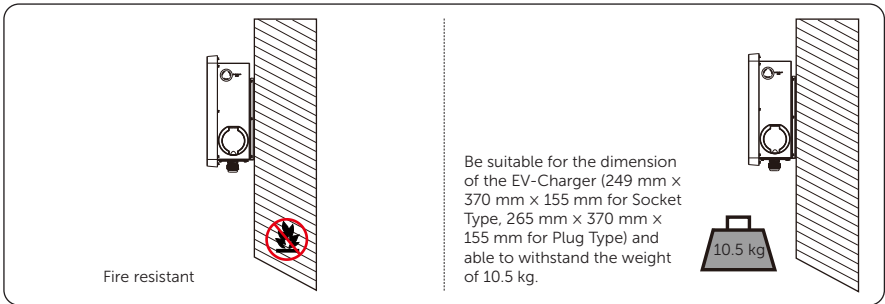

Figure 4-1 Installation carrier requirement

The EV-Charger can also be mounted on EVC Pedestal provided by SolaX. For details, please refer to the *EVC Pedestal Quick Installation Guide*.

4.1.3 Clearance Requirement

To guarantee proper heat dissipation and ease of disassembly and operation, the minimum space around the EV-Charger must meet the standards indicated below.

In areas with high ambient temperatures, increase the clearances and provide adequate fresh air ventilation if feasible.

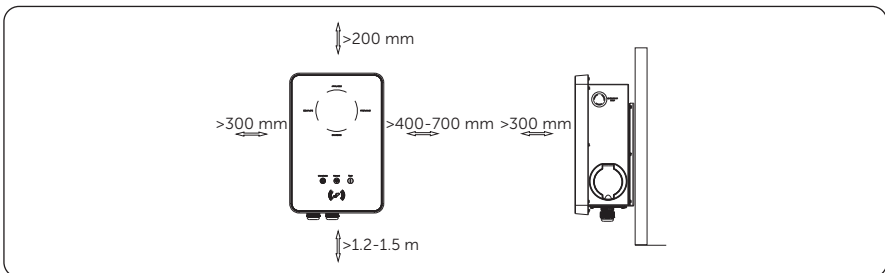
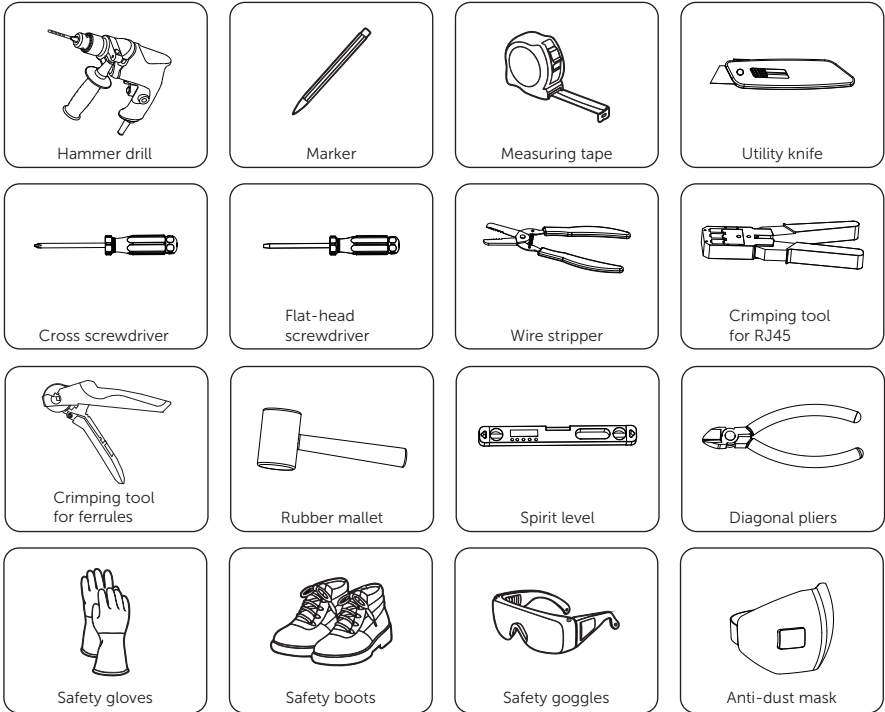

Figure 4-2 Clearance requirement

4.2 Tools Requirement

Installation tools include but are not limited to the following recommended ones. If necessary, use other auxiliary tools on site.



4.3 Additionally Required Materials

Table 4-1. Additionally required Materials

No.	Required Material	Type
1	RCBO *	Type A RCD with a trip current of ≤ 30 mA; 2P and rated current ≥ 40 A for 7 kW, 4P and rated current ≥ 20 A for 11 kW, 4P and rated current ≥ 40 A for 22 kW
2	AC input cable	Three-core copper wire for single-phase, five-core copper wire for three-phase; Outer diameter: 12.5-18 mm; Conductor cross-section for copper wire: ≥ 6 mm ² for 7 kW and 22 kW, ≥ 4 mm ² for 11 kW
3	Communication cable	Network cable CAT5 with RJ45 or two-core cable; Conductor cross-section: 0.2 mm ²
4	RJ45 terminal(s)	/
5	Meter (Optional) **	Contact with the installer for type recommendation

* Please choose appropriate RCBO according to local regulations.

** If OCPP scene is selected, a meter must be installed in the system.

5 Unpacking and Inspection

5.1 Unpacking

- The EV-Charger undergoes 100% testing and inspection before shipping from the manufacturing facility. However, transport damage may still occur. Before unpacking the EV-Charger, please verify that the model and outer packing materials for damage, such as holes and cracks.
- Unpacking the EV-Charger according to the following figures.

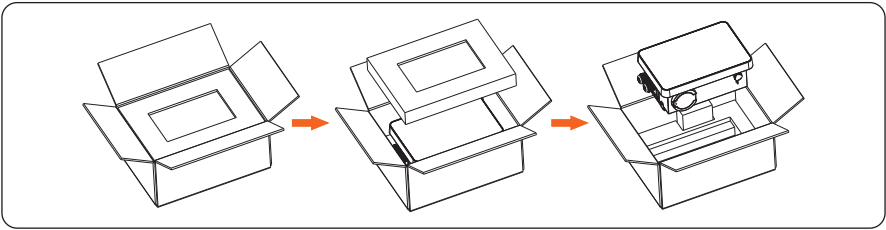

Figure 5-1 Unpacking the Socket Type EV-Charger

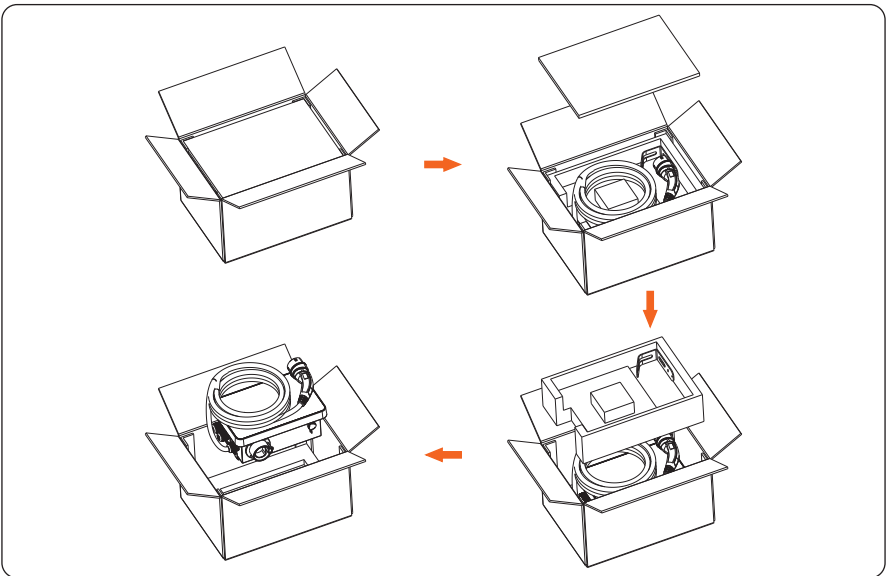





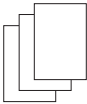

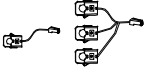



Figure 5-2 Unpacking the Plug Type EV-Charger

- Be careful when dealing with all package materials which may be reused for storage and relocation of the EV-Charger in the future.
- Upon opening the package, check whether the appearance of the EV-Charger is damaged or lack of accessories. If any damage is found or any parts are missing, contact your dealer immediately.

5.2 Scope of Delivery

 <p>EV-Charger x 1</p>	 <p>Expansion tube x 3 or 5 (3 for Socket Type, 5 for Plug Type)</p>	 <p>Self-tapping screw x 3 or 5 (3 for Socket Type, 5 for Plug Type)</p>	 <p>Washer x 3 or 5 (3 for Socket Type, 5 for Plug Type)</p>
 <p>Ferrule x 3 or 5 (3 for single-phase, 5 for three-phase)</p>	 <p>Documents</p>	 <p>RFID card x 2</p>	 <p>Cable hook x 1 (Only for Plug Type)</p>
 <p>CT (for single-phase) or CT (for three-phase) x 1</p>	 <p>RJ45 connector (black) x 1</p>	 <p>Inverter connector (white) x 1</p>	

6 Installation and Wiring

WARNING!

- Only the qualified personnel can perform the mechanical installation following the local standards and requirements.
- Check the existing power cables or other piping in the wall to prevent electric shock or other damage.

CAUTION!

- Always be aware of the weight of the EV-Charger. Personal injuries may result if the EV-Charger is lifted improperly or dropped while being transported or mounted.
- Use insulated tools and wear individual protective tools when installing the EV-Charger.

NOTICE!

- Install the EV-Charger at a maximum back tilt of 5 degrees and avoid forward/backward tilted, side tilted, or upside down.

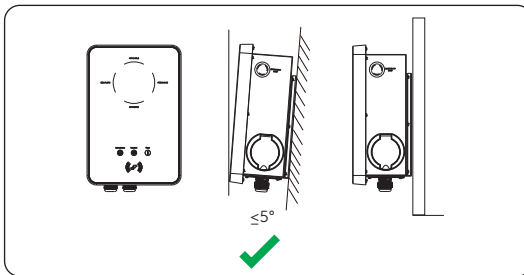

Figure 6-1 Correct installation

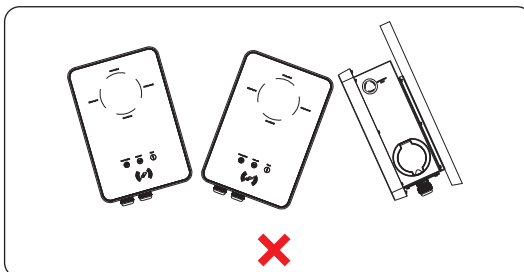

Figure 6-2 Incorrect installation

6.1 Decide Application Scenario

The EV-Charger offers different application scenarios and the communication connection is different under different application scenario. Please decide the application scenarios before installation.

Home Scene

- Communication with CT/Meter

The EV-Charger can work with the inverter system which does not support communication with it to form an intelligent photovoltaic, storage and EV charging energy system. Through communicating with CT or meter, the EV-Charger can obtain the current information and realize the smart control of different charging modes. However, if the inverter has zero injection requirement, Green or Eco charging mode of the EV-Charger may not work normally.

The EV-Charger can also work without the inverter system, but realize the smart control of the charging modes through communicating with CT or meter.

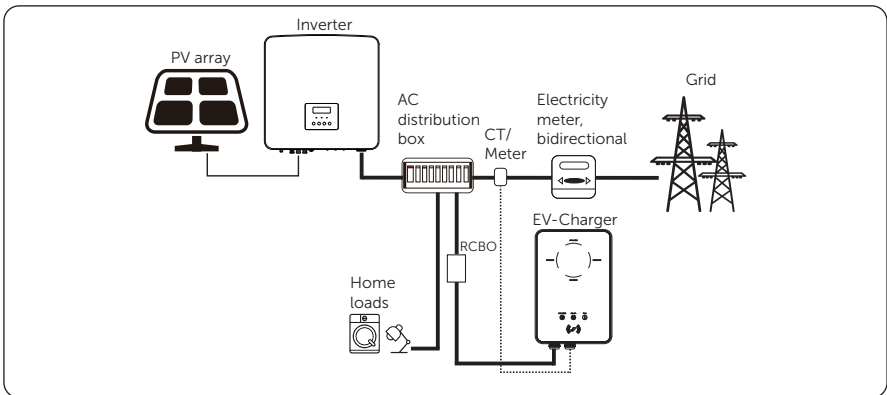

Figure 6-3 Home scene and communication with CT/meter

- Communication with Inverter

The EV-Charger can work with the inverter system which supports communication with it to form an intelligent photovoltaic, storage and EV charging energy system. Through communicating with the inverter, the EV-Charger can obtain the current information of the grid and PV and realize the smart control of different charging modes.

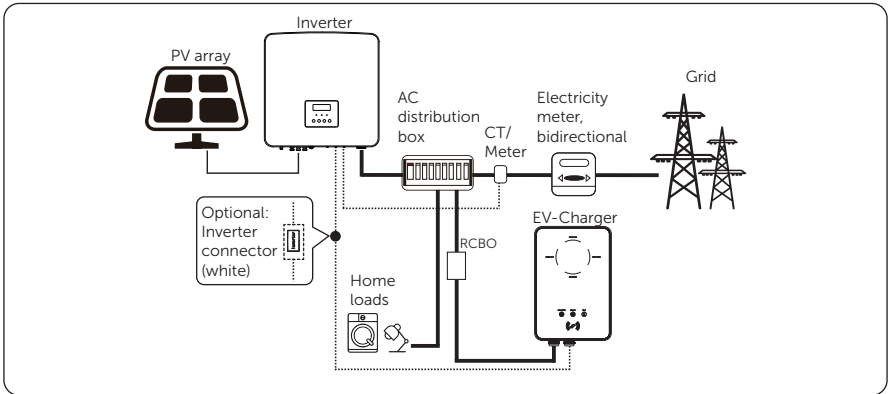

Figure 6-4 Home scene and communication with inverter

NOTICE!

- If the system has zero injection requirement, the EV-Charger must communicate with the inverter.
- When communicating with the inverter, it is recommended to use a two-core cable as the communication cable since it is more waterproof. If users use eight-core cable as the communication cable, the white inverter connector must be used to allow the system to work normally. For details, please refer to "[6.2 Installation and Wiring Steps](#)".

OCPP Scene

The EV-Charger can be connected with the OCPP server and controlled by the OCPP server.

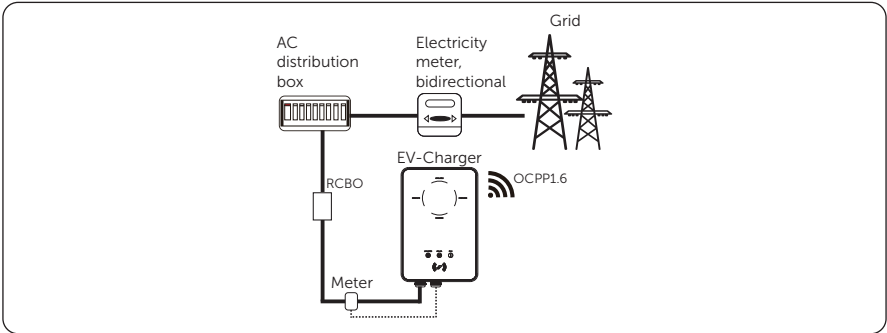

Figure 6-5 OCPP scene

6.2 Installation and Wiring Steps



WARNING!

- Disconnect the AC power supply before electrical connection. Do not work with the power on, or electric shock may occur.
- All electrical connections must be carried out by qualified personnel in accordance with legislation in force in the country concerned.

The following descriptions of installation and wiring steps are described taking three-phase EV-Charger as an example.

Step 1: Remove the screw from the EV-Charger with the cross screwdriver. Then remove the back bracket away carefully.

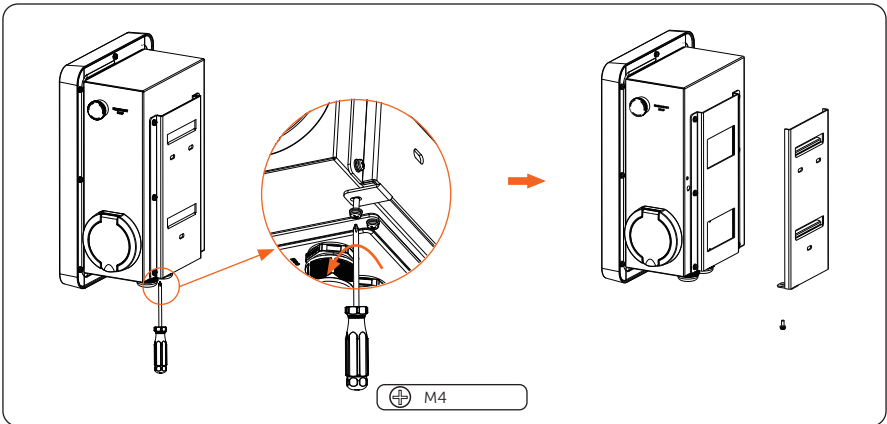

Figure 6-6 Remove the back bracket away

Step 2: Fix the back bracket and the cable hook (only for Plug Type) to the wall.

- a. Use the back bracket as a template to mark the position of the holes on the wall.

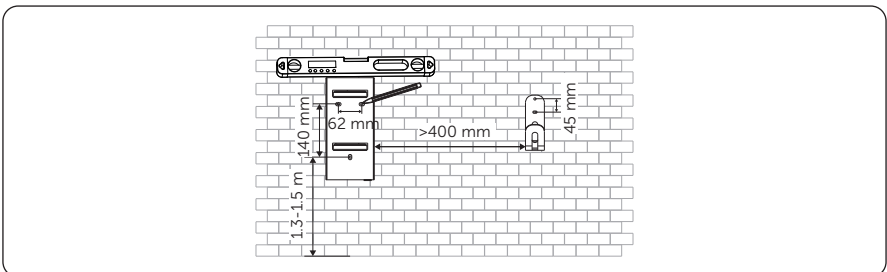

Figure 6-7 Mark the holes

NOTICE!

- Observe the bubble of spirit level and adjust the wall bracket until the bubble stays in the middle.
- b. Drill holes with $\varnothing 8$ drill, make sure the holes are deep enough for the installation (Depth: at least 45 mm).

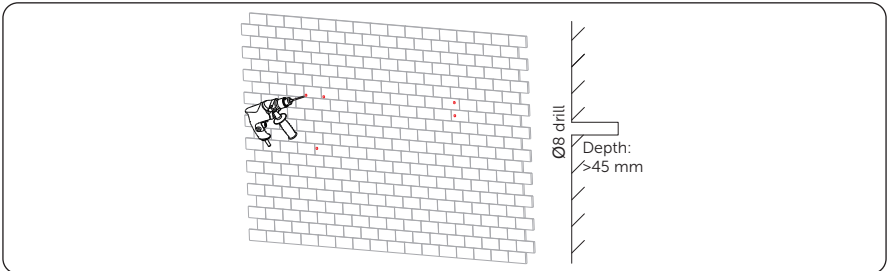

Figure 6-8 Drill the holes

- c. Insert the expansion tubes in the holes.

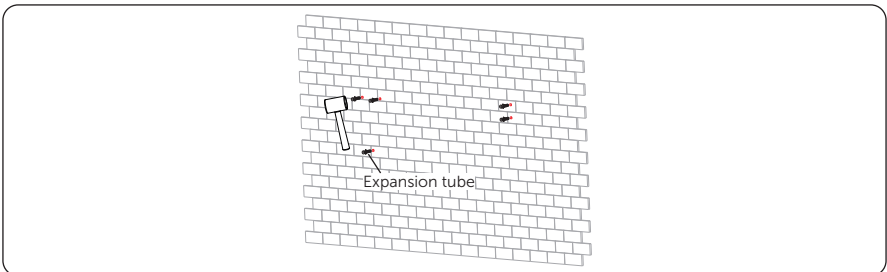

Figure 6-9 Insert the expansion tubes

- d. Align the bracket and the cable hook (only for Plug Type) with the holes, and screw the self-tapping screws with the cross screwdriver.

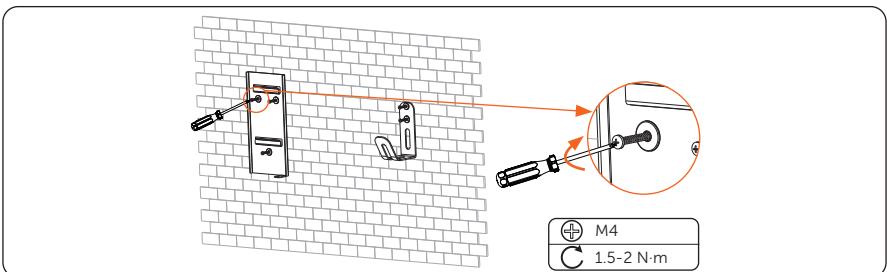

Figure 6-10 Secure the bracket and the cable hook

- Step 3:** Hang the EV-Charger on the wall for trial, then estimate the required length of AC input cable and communication cable(s). After that, take the EV-Charger down.
- Step 4:** Unscrew the EV-Charger's rear cover with the cross screwdriver and take it down. Then undo the fastening heads and take the waterproof materials away as shown below.

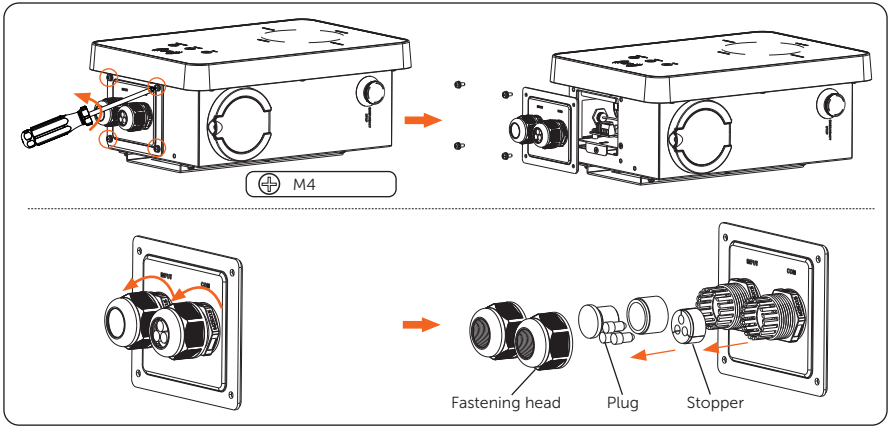

Figure 6-11 Take down and disassemble the rear cover

- Step 5:** Unscrew the countersunk screw of the base plate of communication board with the cross screwdriver. Then pull the base plate of communication board out. The connection ports inside are shown as below.

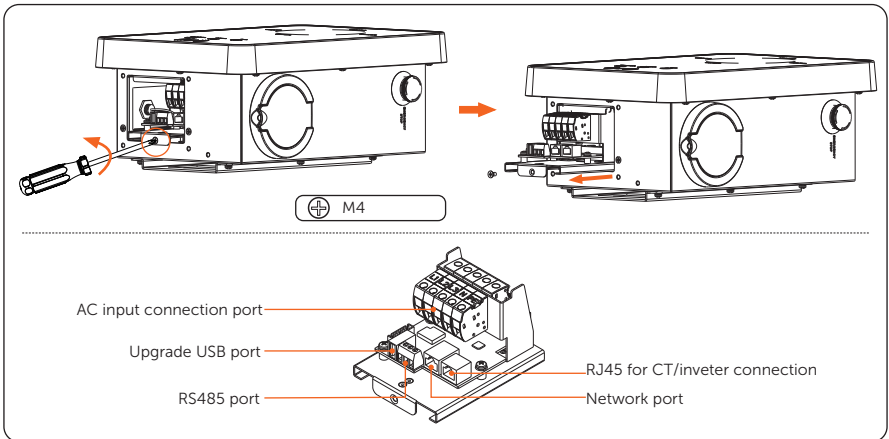

Figure 6-12 Pull the base plate of communication board out

Step 6: Prepare and process the AC input cable.

- a. Strip the insulation jacket of the AC input cable as below, ensuring all the wires can reach the terminal blocks with a little excessive length. Use the wire stripper to strip approximately 12 mm of insulation from the end of all the coloured wires as below.

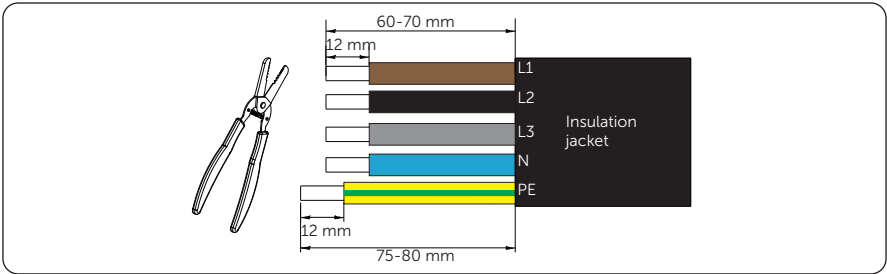

Figure 6-13 Strip the AC input cable

- b. Place the ferrules on the stripped parts of the wires, and crimp the ferrules on L1, L2, L3, N and PE wire respectively.

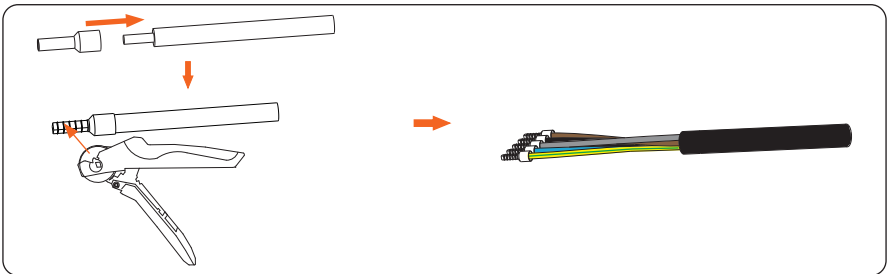

Figure 6-14 Crimp the wires

Step 7: Choose and prepare communication cable(s) as the actual application scenario required.

- Communication cable for connecting CT or Network

If the cable is self-made, pay attention to pin order of RJ45 terminal and make sure the wires are firmly crimped with the RJ45 terminal.

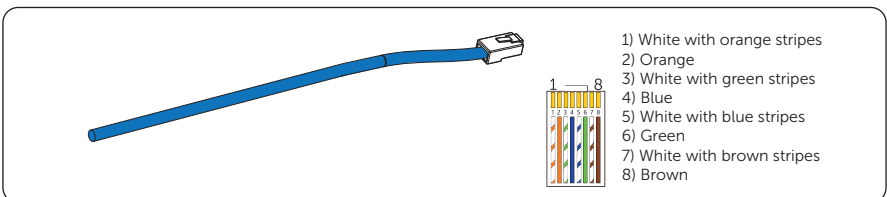

Figure 6-15 Communication cable for connecting CT or Network

- Communication cable for connecting Meter

Strip 10-15 mm of the cable insulation jacket and then strip 5 mm of insulation of the conductors.

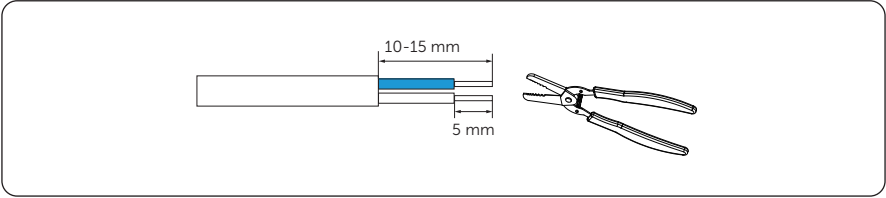

Figure 6-16 Communication cable for connecting Meter

- Communication cable for connecting Inverter

- » Two-core cable (Recommended)

Strip 15 mm of the cable insulation jacket and insert the stripped part into Pin 4 & 5 of the RJ45 terminal, then crimp the RJ45 terminal with the crimping tool for RJ45.

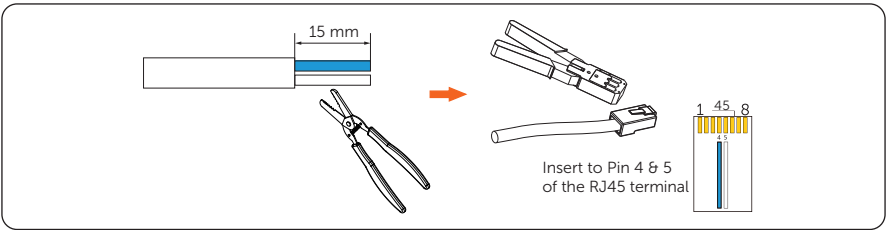

Figure 6-17 Communication cable for connecting Inverter (two-core cable)

- » Eight-core cable (Should be used with the inverter connector)

If the cable is self-made, pay attention to pin order of RJ45 terminal and make sure the wires are firmly crimped with the RJ45 terminal.

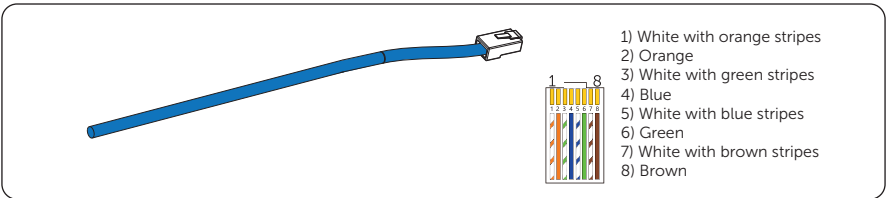

Figure 6-18 Communication cable for connecting Inverter (eight-core cable)

Step 8: Thread the AC input cable in sequence as shown below.

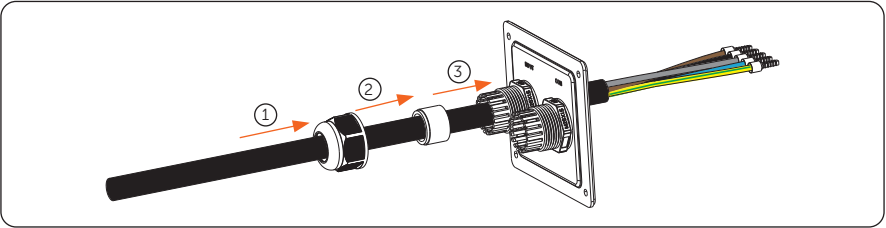

Figure 6-19 Thread the AC input cable

Step 9: Thread the communication cable(s) in sequence as shown below. Put the plug(s) back to the unused hole(s) of the stopper. (Take communication cable for connecting CT as an example from hereupon unless otherwise specified.)

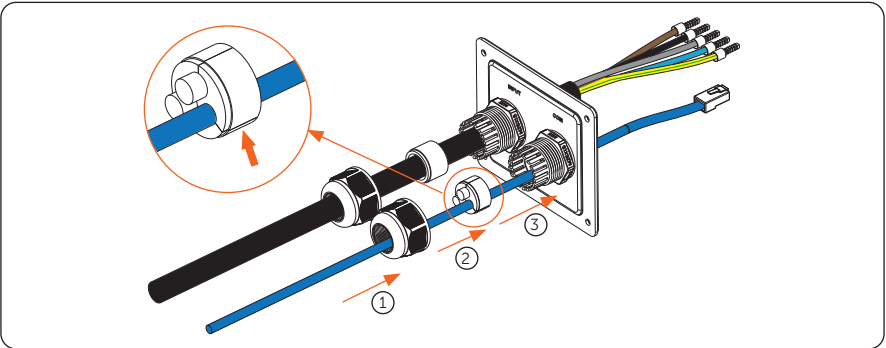

Figure 6-20 Thread the communication cable

Step 10: Insert the crimped parts of the L1, L2, L3, N and PE wire into the corresponding holes of the AC input connection port on the base plate of communication board, then secure the wires with the flat-head screwdriver.

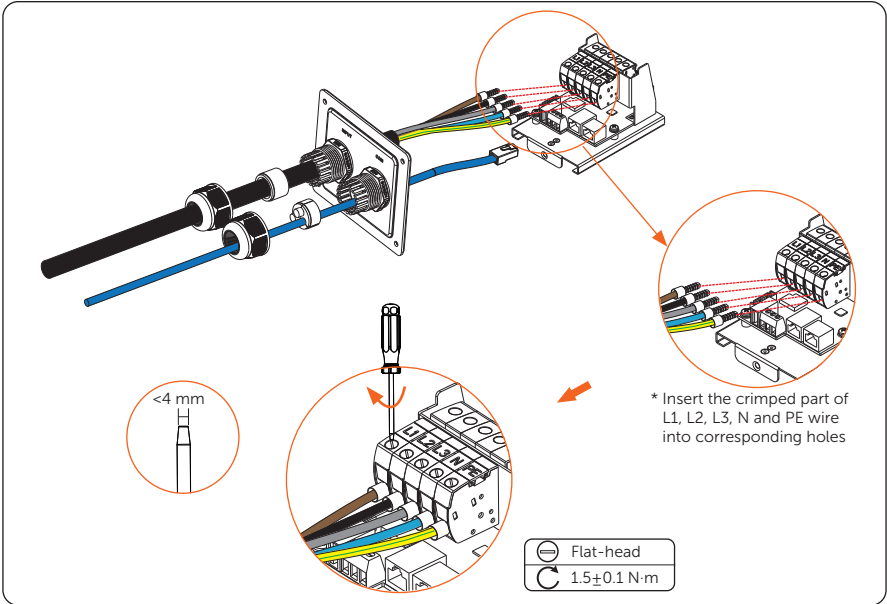

Figure 6-21 Connect the AC input cable

Step 11: Connect the communication cable to the corresponding communication port.

Pin definition of communication ports

- Pin definition of RJ45 for connecting CT and inverter

Table 6-1 Pin definition of RJ45 for connecting CT and inverter

Pin	1	2	3	4	5	6	7	8
Pin Definition	L1_CT+	L1_CT-	L2_CT+	A1	B1	L2_CT-	L3_CT+	L3_CT-

* PIN 3, 6, 7, 8 is null for single-phase. Pin 4 & 5 are for connecting inverter.

NOTICE!

- When connecting with inverter, make sure not to use all-pass eight-core communication cable, please use with the white inverter connector or use two-core cable instead.

- Pin definition of RS485 for connecting meter

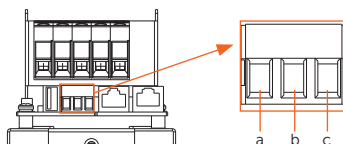

Figure 6-22 RS485 port

Table 6-2 Pin definition of RS485 for connecting meter

Pin	a	b	c
Pin Definition	GND	A2	B2

Connection method

Complete the communication connection as the actual application scenario needed.

- Communication with CT

Connect the communication cable connected with CT to the RJ45 port on the base plate of communication board.

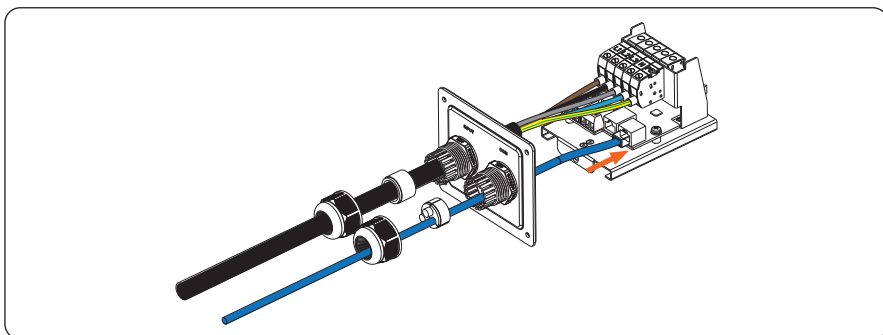

Figure 6-23 Connect the communication cable to RJ45 port

- » For CT side, steady the CT on the public grid.

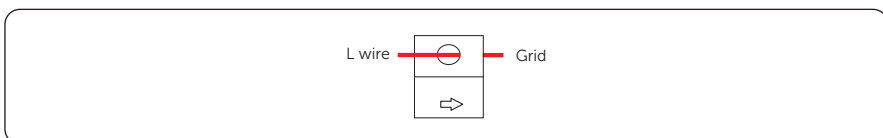

Figure 6-24 CT side connection

NOTICE!

- The arrow on the CT must point at the public grid.
- Do not place the CT on the N Wire or the PE wire.
- Do not place the CT on the N and L wire simultaneously.
- Do not place the CT on the non-insulated wires.
- When using the three-phase CT, please clip the CT clamps on the corresponding phases (CT-R must be connected to grid L1, CT-S connected to grid L2, CT-T connected to grid L3).

* If extended communication cable is needed when connecting with CT, use the RJ45 connector to connect the communication cable connected with the EV-Charger and the other one connected with CT.

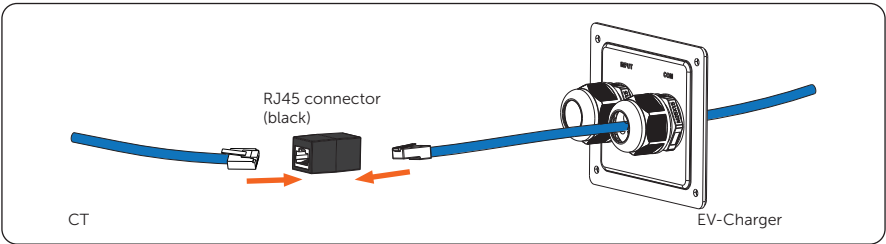

Figure 6-25 Using RJ45 connector

- Communication with Meter

Insert the stripped parts of the conductors into the RS485 port following the Pin definition and then secure them with flat-head screwdriver.

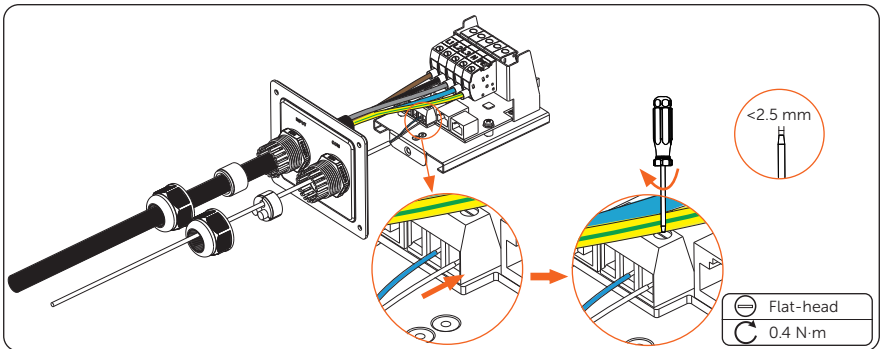

Figure 6-26 Connect the communication cable to RS485 port

- Communication with Inverter

Connect the communication cable connected with the inverter to the RJ45 port on the base plate of communication board.

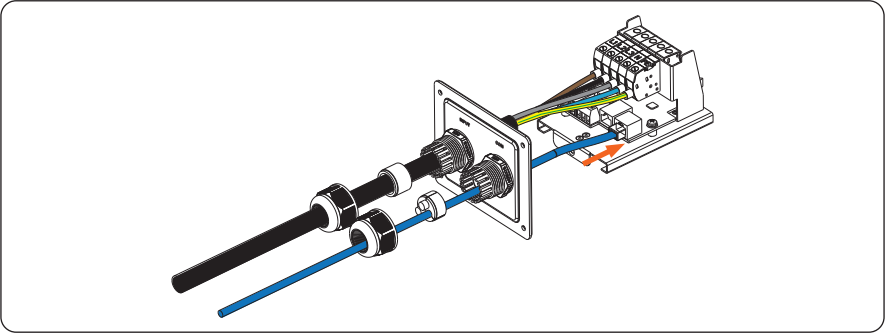

Figure 6-27 Connect the communication cable to RJ45 port

- » For inverter side, connect the other end of the communication cable to the COM or RS485 port of the inverter according to the definitions of the communication ports of the specific inverter.

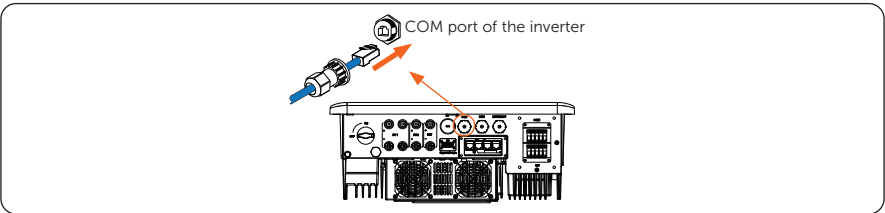

Figure 6-28 Inverter side connection (one example)

* If eight-core cable is used when connecting with the inverter, please use the white inverter connector to connect the communication cable connected with the EV-Charger and the other one connected with the inverter to allow the system to work normally.

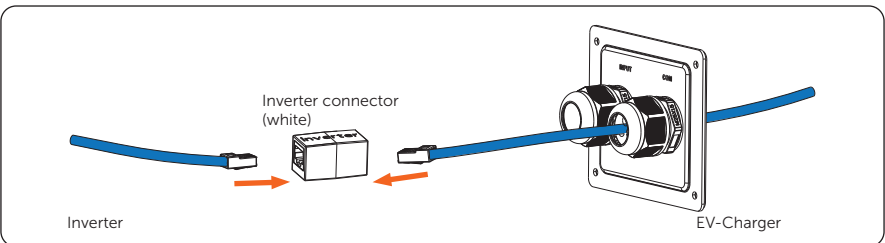

Figure 6-29 Using the white inverter connector

- Communication with Network

Network connection is optional for areas where remote WiFi connection is not available or has a weak signal. Users can choose to finish the network connection as needed.

Connect the communication cable for network to the Network port on the base plate of communication board.

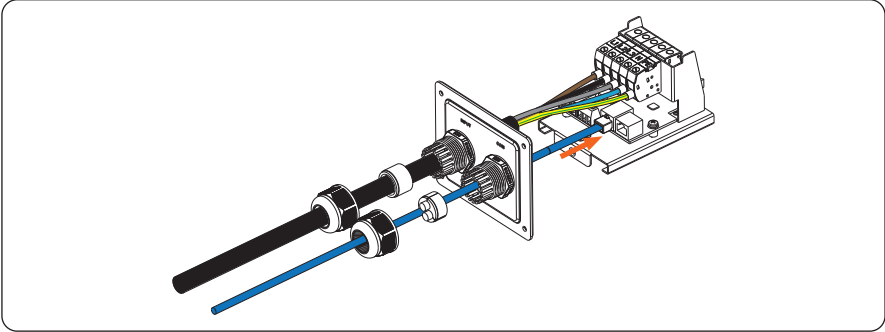

Figure 6-30 Connect the communication cable to Network port

 **WARNING!**

- The Ethernet cable used to connect the EV-Charger for communication must be protected from lightning strikes.

Step 12: Press the spring upward and push the base plate of communication board in. Then screw the countersunk screw.

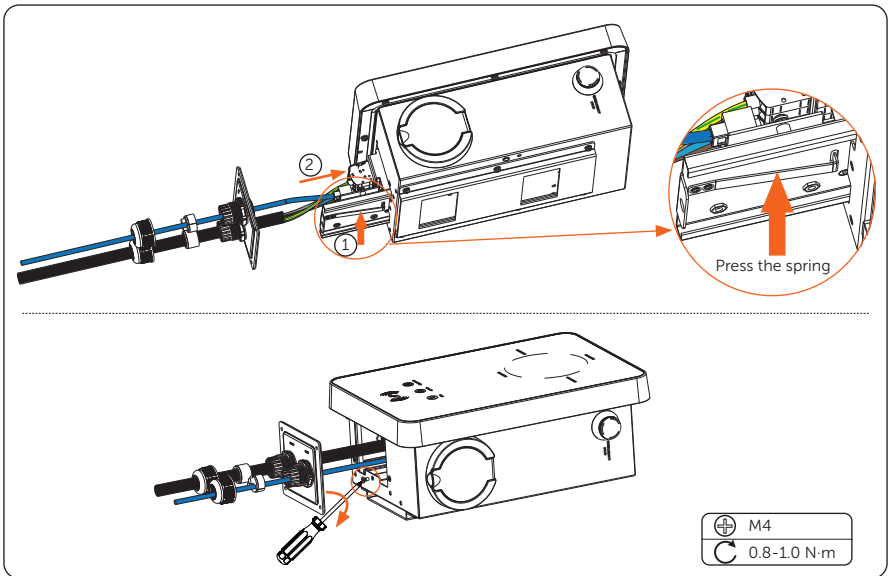

Figure 6-31 Screw the the base plate of communication board

Step 13: Push the rear cover, stoppers and fastening heads to appropriate position of the cables. Then screw the self-tapping screws with the cross screwdriver and tighten the waterproof fastening heads.

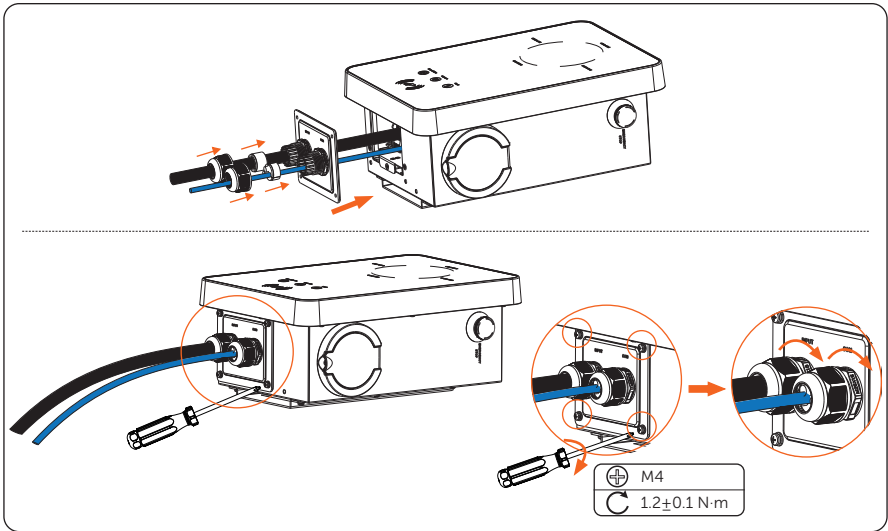

Figure 6-32 Secure the rear cover

Step 14: Hang the EV-Charger up carefully and steady the EV-Charger with the self-tapping screw and the cross screwdriver.

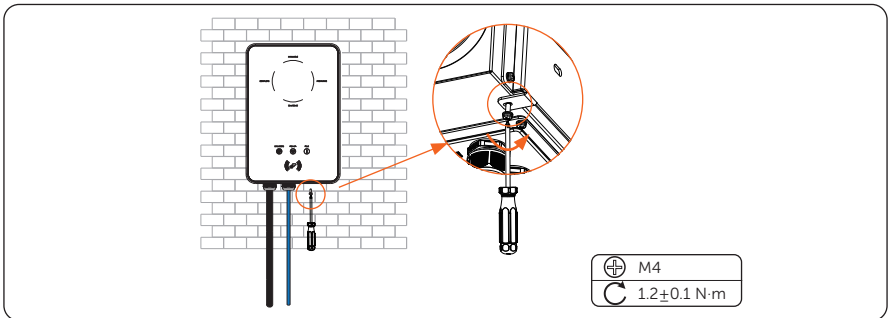

Figure 6-33 Hang and steady the EV-Charger

For Plug Type, connect the charging connector with the EV-Charger and hang the connecting cable on the cable hook.

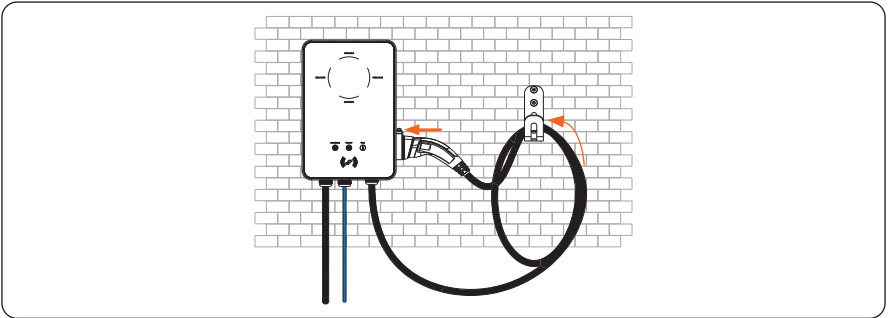

Figure 6-34 Connect the charging connector and hang the cable

7 Power on

7.1 Checking before Powering on

Check all below steps before powering on the EV-Charger:

- a. Check that the device is installed correctly and securely;
- b. The AC input cable is connected correctly and securely;
- c. The communication cables are connected correctly and securely;
- d. The voltage, frequency and other factors of the grid are in consistent with the working requirement of the EV-Charger.

7.2 Powering on

Step 1: Turn on the RCBO.

Step 2: Check the status of the LED indicators: When the device is powered on, all the LED indicators will be on for three seconds, then the system will start self-checking automatically. After the checking process, the "AVAILABLE" light will be on when the charging connector is not plugged and the "PREPARING" light will be on when plugged.

If the "Fault" light is on, please check if it is correctly installed and connected.

WARNING!

- Power to the device must be turned on only after installation work has been completed.
- The device is intended only for charging electric vehicles. Do not charge other devices.

8 App Setting

8.1 Download, Registration and Login

SolaX Cloud provides customers with a platform that can monitor SolaX EV-Charger data and set it remotely. The EV-Charger connects the system with built-in WiFi or LAN network connection, and upload the operation data to SolaX Cloud every 5 minutes. You can log in to your user account at any time through a personal computer, IOS or Android device to view real-time monitoring data or historical data, and perform remote settings as needed.

8.1.1 Downloading and installing App

Select and scan the QR code below to download SolaxCloud App. You can also find the QR codes at the top left of the login page of www.solaxcloud.com. In addition, you can search with the key word "SolaxCloud" in Apple Store or Google Play to download it.



App Store

Google play

Figure 8-1 QR code

* The screen shots hereupon are for reference only, and the actual interfaces may differ. You can update your App as needed.

8.1.2 App Registration and Login

Step 1: Run the App and touch **Create a new account** at the bottom of Monitoring App.

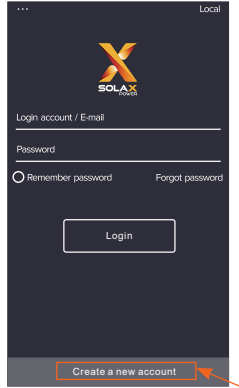

Figure 8-2 Creating a new account

Step 2: Fill in your registration Email, input the Verification code, and enter your password to create the account. Log in the App after registration finished.

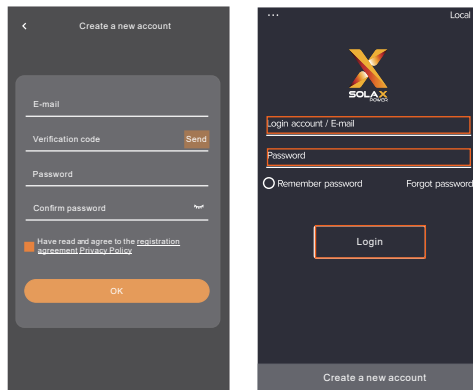

Figure 8-3 Login

NOTICE!

- App registration via **Create a new account** is for end-users. If you want to apply for an account of agent, please send an email to: service@solaxpower.com.

Step 3: For the first login, complete the site creation and Wi-Fi configuration as below.

- a. Click **+** to create your site.

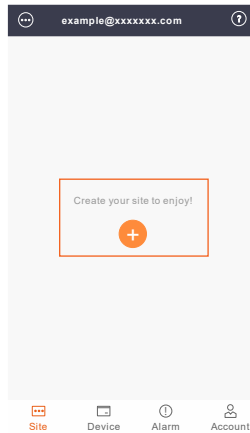

Figure 8-4 Creating the site

- b. Allow SolaxCloud to access your system location, fill in site name (self-defined), system size (For the system size, please check the information with the installer), choose the following settings according to actual situations, and add device by typing in or scanning the Registration No. on the type label.

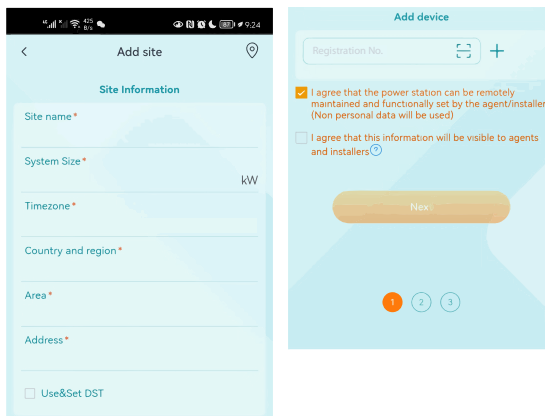

Figure 8-5 Site information

NOTICE!

- Select **Use&Set DST** if your country has summer time and winter time.

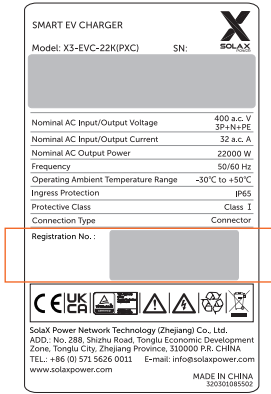

Figure 8-6 One example for Registration No.

- c. Enter your WiFi account and password. Start to configure the device network. DHCP is enabled by default to distribute IP address automatically. 5GHz network is not supported.

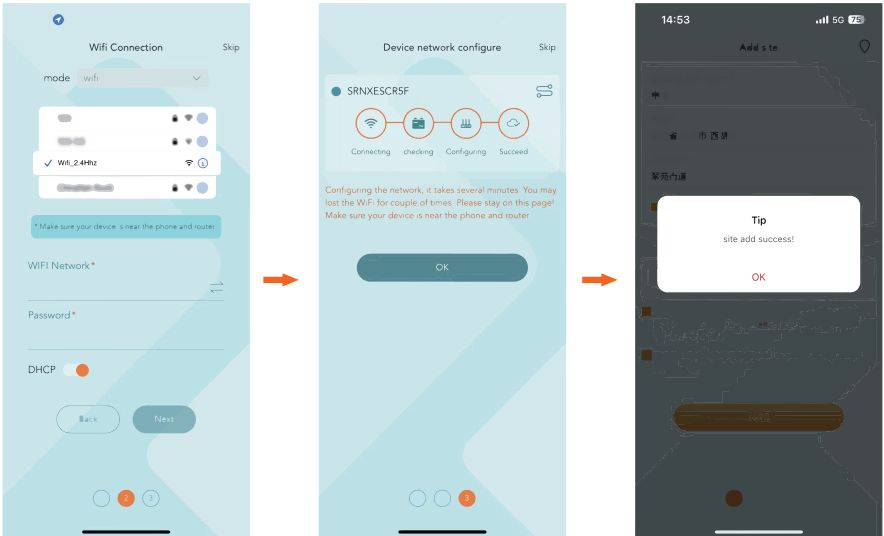

Figure 8-7 Wi-Fi configuration

8.2 Configuration

NOTICE!

- If you already have the App account, you can proceed to the configuration after login.

8.2.1 Add Device

Step 1: Login your account and turn to the **Device** page in the App.

Step 2: Touch the **+** icon on the upper right corner and fill in the information to add the EV-Charger.

Site*

Default Site v

Registration No.*

+

OK

Figure 8-8 Add device

8.2.2 Wi-Fi Connection

Step 1: Turn to the **Account** page in the App.

Step 2: Click **Wifi Connection**.

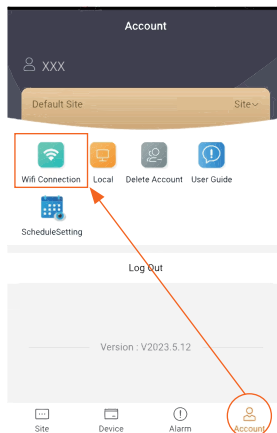

Figure 8-9 Click Wifi Connection

Step 3: Type in or scan the Registration No. of the EV-Charger. Then touch **Next** and agree to join the network of the EV-Charger.

Registration No.*

Next

Figure 8-10 Type in or scan the Registration No.

Step 4: Type in or choose your home Wi-Fi SSID and password, then touch **Next**.

* 5GHz Wi-Fi is unavailable for now.

WIFI Network*

Password*

Back Next

Figure 8-11 Type in Wi-Fi SSID and password

Step 5: Follow the instructions to complete Wi-Fi setting, there will be a note when the setting successes.

*Check more Wi-Fi setting information on www.solaxcloud.com/wifiSetting/

NOTICE!

- If the Wi-Fi connection fails, users can connect to the WiFi signal named after the device registration number and visit the IP address <http://192.168.10.10/> in a browser to configure Wi-Fi. (Account: "admin"; default password: the Registration No.)
- If users connect to the network server through LAN, there is no need to set the WiFi configuration, as it will be automatically configured.

8.2.3 Local Mode

Use your smart phone to connect the SolaX Wi-Fi signal (Wifi_Sxxxxxxx). Then touch **Local** and type in the password (initially same as the Registration No.) to access the Local Mode in the Monitoring App.

* Visit the local password setting instruction on www.solaxcloud.com/wifiSetting/

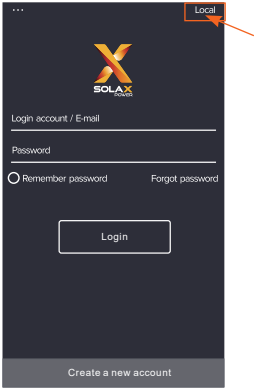

Figure 8-12 Local

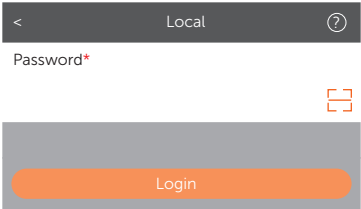

Figure 8-13 Password for local mode

8.3 Settings for EV-Charger

8.3.1 Operation to Enter the Setting Page

Step 1: Turn to the **Site** page in the App.

Step 2: Touch the **EV Charger** icon.

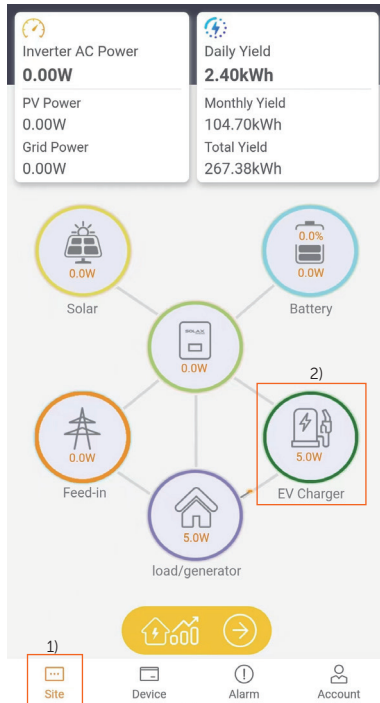

Figure 8-14 Select EV Charger

Step 3: Select your EV-Charger on the list. From the list, the Registration No, Charger Status, Energy and Site name information is displayed.

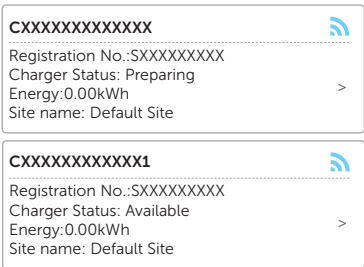

Figure 8-15 Select from the list

Step 4: After that, control page will be shown.

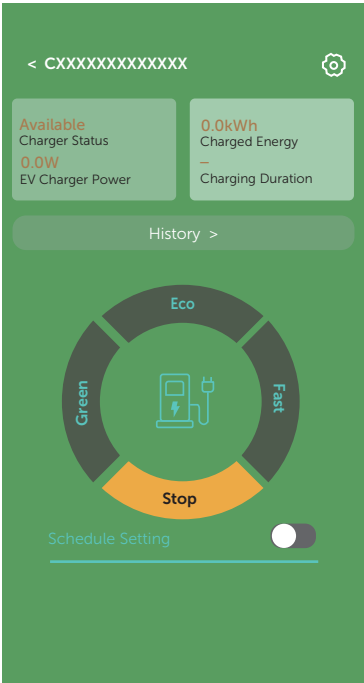

Figure 8-16 Control page

On this page, the charging information can be seen, including the Charger Status, EV Charger Power, Charged Energy and Charging Duration.

Users can touch **History** to review the charging records which contains information of charging energy, duration and start time.

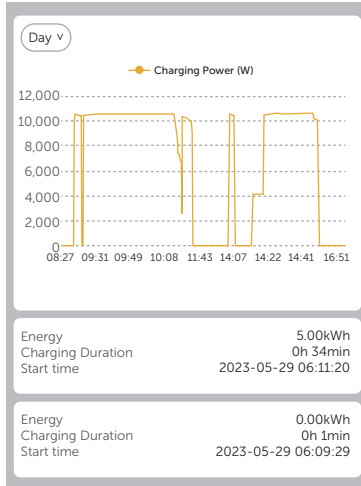

Figure 8-17 History page

Users can switch between Green, Eco and Fast charging modes and stop charging on control page by touching the corresponding area as well as complete the boosting settings and schedule setting here. For details, please refer to "[9.5 Detailed Function Operation](#)".

Users can touch the setting button on the upper right of the control page to enter the setting page.

Step 5: Touch the setting button on the control page to enter the setting page.

The setting page contains three parts: Basic information, Charger setting, Advanced setting. Touch the > on the right side of each item can enter to the next level.

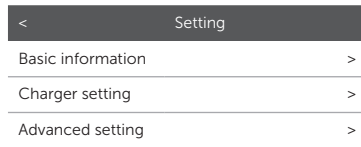

Figure 8-18 Setting page

8.3.2 Overview of the Setting Page

Basic Information

Enter the Basic information page, there are four items displayed: Charger ID, Date Time, Timezone and Verison.

< Basic information	
Charger ID	CXXXXXXXXXXXX
Date Time	2023-05-26 10:55
Timezone	(UTC) Coordinated Universal Time
Version	V1.25

Figure 8-19 Basic information page

Date Time will be automatically synchronized. If it is not correct, please adjust it by yourself.

Confirm the **Timezone** according to the application location. After logging in to the App, the **Timezone** will be automatically located. If it is not correct, please adjust it to the correct one.

Charger Setting

Enter the Charger setting page, there are five items: Application scene, Activation mode, Work mode setting, Dynamic load balance and Modbus Setting.

< Setting	
Application scene	Home
Activation mode	Plug&Charge
Work mode setting	Green:3A ECO:6A
Dynamic load balance	Disable
Modbus Setting	70/9600
LCD Language	English

Figure 8-20 Charger setting page

The default **Application scene** is **Home**, if the user wants to use OCPP scene, please refer to "[9.3 Application Scene Setting](#)".

LCD Language is only for models with LCD screen, users can select the language type according to actual needs.

The other settings on this page by default will only be shown and take effect in Home scene. For details, refer to "[9.5 Detailed Function Operation](#)".

Advanced setting

Enter the Advanced setting page, there are the following items: Alarm setting, Charging restrict, Random charging delay, Three phase imbalance (only for single-phase EV-Charger), Restore factory settings, EV Charger Reset.

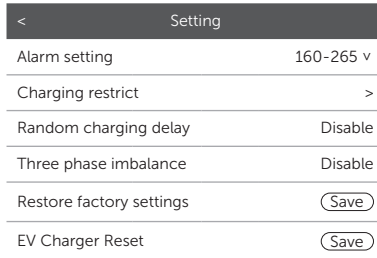

Setting	
Alarm setting	160-265 v
Charging restrict	>
Random charging delay	Disable
Three phase imbalance	Disable
Restore factory settings	Save
EV Charger Reset	Save

Figure 8-21 Advanced setting page

The **Alarm setting** contains **Overvoltage Limit** and **Undervoltage Limit**. Set and save these two values according to local regulations.

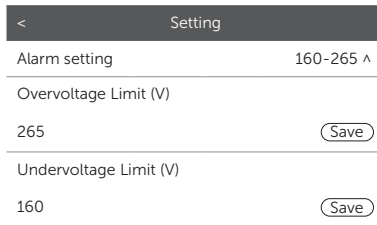

Setting	
Alarm setting	160-265 ^
Overvoltage Limit (V)	265 Save
Undervoltage Limit (V)	160 Save

Figure 8-22 Alarm setting

For the detailed operation of Charging restrict, Random charging delay, Three phase imbalance, please refer to "[9.5 Detailed Function Operation](#)".

The default settings can be restored by touch **Save** for **Restore factory settings**.

The EV-Charger can be reset and all the LED indicator lights will be on when touch **Save** for **EV Charger Reset**.

9 Operation Method

9.1 States

The states of this series of EV-Charger are described as below:

Table 9-1 States

State	Indicator Light & Description
Available	The "AVAILABLE" indicator light is on. The EV-Charger is powered on but the charging connector is not plugged into the EV.
Preparing	The "PREPARING" indicator light is on. The EV-Charger is connected with the EV but not charging.
Charging	The "CHARGING" indicator light is on or flashing. When the light is on, the EV-Charger is charging normally; when it is flashing, the charging is suspended due to some certain reason.
Finishing	The "COMPLETE" indicator light is on. The EV-Charger has completed charging.
Unavailable	The "Unavailable" indicator light is on. The EV-Charger cannot charge even if the charging connector is plugged in.
Network	The "Network" indicator light is on. The EV-Charger has been successfully connected with network server.
Fault	The "Fault" indicator light is on. The EV-Charger is in fault state.
Upgrade	The upper four operating status indicator lights will flash at the same time. The EV-Charger is remote upgrading.
RFID card Rewrite	The upper four operating status indicator lights will light up in sequence and cycle. The RFID card is being rewrote.

9.2 Start-up Patterns

The EV-Charger has three start-up patterns in total, namely plug & charge, card-swiping, and APP activation pattern. There is a built-in electronic lock in Socket Type.

Home scene

In Home scene, all the three start-up patterns are available and the default pattern is plug & charge. The **Activation mode** must be selected as **RFID** on the App if the card-swiping pattern is to be used.

- Plug & charge pattern

For Socket Type, the electronic lock will be locked when the EV-Charger starts charging and unlocked automatically when the charging stops.

For Plug Type, there is no electronic lock.

- Card-swiping pattern and APP activation pattern

For Socket Type, the electronic lock will be locked when the EV-Charger starts charging after swiping the card or touch corresponding charging mode area on the control page of the App. If the charging process is stopped by the user (either by swiping card or touch **Stop** on the App), the electronic lock will be unlocked automatically. If the charging process is completed (i.e. the EV is fully charged), the electronic lock should be unlocked by swiping the card.

For Plug Type, there is no electronic lock.

OCPP scene

While in OCPP scene only card-swiping pattern is available and should be in accordance with the OCPP server. For Socket Type, the electronic lock will be locked when the EV-Charger starts charging after swiping the card, and the charging process will end after swiping the card for the first time and the electronic lock will be unlocked after swiping for the second time.

NOTICE!

- In emergency cases, please stop the EV-Charger by pressing the EMERGENCY STOP button.

9.3 Application Scene Setting

The default **Application scene** is **Home**. If the user wants to use the OCPP scene, select on the setting page following the path: **Charger setting > Application scene > OCPP**.

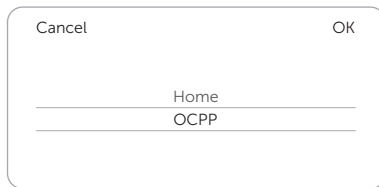

Figure 9-1 Select OCPP as Application scene

In OCPP scene, the EV-Charger can be connected with the OCPP server. Before choosing this scene, please ensure that the EV-Charger has met the following prerequisites:

- The EV-Charger has joined the network that can access the Internet through network connection.

- A valid "URL" address has been obtained from the OCPP server.

A valid "URL" address usually starts with "ws://" or "wss://". For example, ws://xxxxxx.com:8080/ChargeCentralSystem/CPXXXXXXX or wss://xxxxxx.com/ChargeCentralSystem/CPXXXXXXX.

For more details, please consult with the seller or the OCPP server.

- A valid charger ID has been obtained from the OCPP server.
- The network is normal and the OCPP server can be connected. When the EV-Charger has been connected to the OCPP server successfully, the "Network" light will be on.

NOTICE!

- Only with a valid address and a valid charger ID obtained from the OCPP server, can the EV-Charger be connected to the OCPP server through the Internet and access the various functions provided by the server.

After **OCPP** scene is selected, type in the **OCPP Server** address and **Charger ID** obtained from the OCPP server and touch **Save**. A **Setting success** notice will appear when saved successfully.

For models with LCD screen, users can also define the QR code displayed by setting and saving the information in **LCD QR Code** item.

The screenshot displays a mobile application interface for setting an OCPP scene. At the top, there is a dark grey header with a left-pointing arrow and the word "Setting". Below this, the text "Application scene" is followed by "OCPP" on the right. A horizontal line separates this header from the input fields. There are five input fields: the first is "OCPP Server", the second is "OCPP Server", the third is "Charger ID", the fourth is "Charger ID", and the fifth is "LCD QR Code". To the right of the "LCD QR Code" field is a green button with the word "Save" in white. At the bottom of the screen, there is a large, rounded rectangular button with the word "Save" in the center.

Figure 9-2 OCPP scene setting

9.4 RFID Function Operation

If the user wants to switch to the card-swiping pattern from the default pattern in home scene, the user needs to select **RFID** for **Activation mode** on the App following the path: **Charger setting > Activation mode > RFID**.

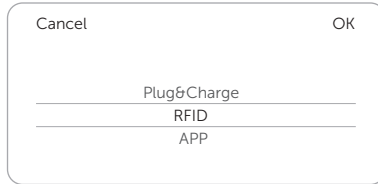

Figure 9-3 Select activation mode

The RFID card has been activated before delivery and the user can change the RFID Pin after installation following the instructions below:

- a. When the **Activation mode** is selected as **RFID**, touch **Change** button.

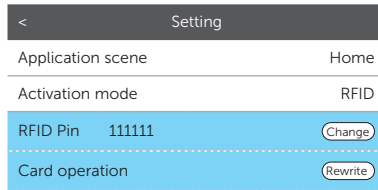

Figure 9-4 Touch Change

- b. Input the new RFID Pin. The default **RFID Pin** is 111111, the user can modify it by inputting the new pin. The new RFID Pin should be 6 digits. Then touch **Save**.

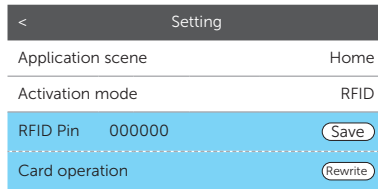

Figure 9-5 Input new RFID Pin and save

- c. Touch **Rewrite** for **Card operation**, the upper four operating status indicator lights on the EV-Charger will light up in sequence and cycle.

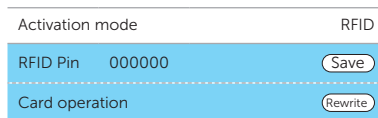

Figure 9-6 Rewrite

- d. Put the RFID card on the swipe zone of the EV-Charger at this time. If it is successfully rewrote, the EV-Charger will beep.
- e. Then touch **Complete** to finish the operation.

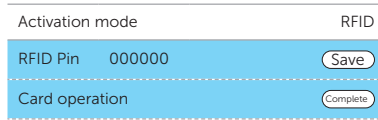

Figure 9-7 Complete

NOTICE!

- The RFID card from the accessory bag will be invalid in OCPP scene.

9.5 Detailed Function Operation

9.5.1 Charging modes in Home Scene

When **Home** scene is selected, there are three charging modes (Green, Eco & Fast) and two kinds of boost settings available (Smart Boost & Timer Boost). The default charging mode is Fast mode, and the users can switch among the charging modes on the control page of the App. The boost settings will only take effect in Green and Eco modes.

Green mode

In Green mode, the EV-Charger will maximize the use of surplus power generated from the inverter. According to the minimum start-up charging power, the charging current can be divided into two levels as 3 A and 6 A. The default level is 3 A.

In the 6 A level, the EV-Charger won't use the power generated from grid at all.

In the 3 A level, the EV-Charger would start charging only when photovoltaic power supply is more than 3 A. Meanwhile, if the photovoltaic power supply is less than 6 A, the EV-Charger needs to buy extra electricity from grid for minimum start-up charging power (1.4 kW for single-phase, 4.2 kW for three-phase).

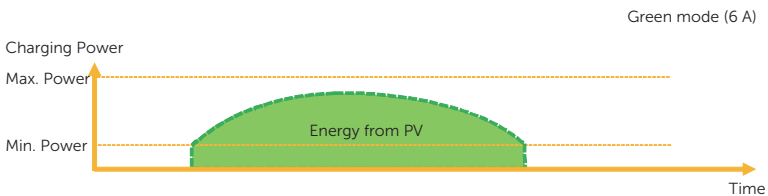

Figure 9-8 Green mode in the 6 A level

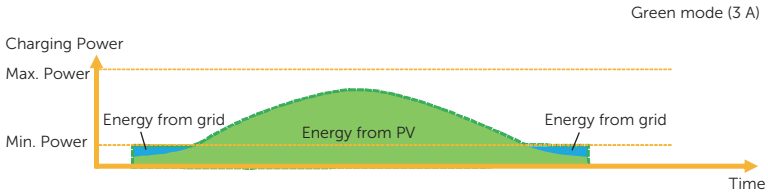

Figure 9-9 Green mode in the 3 A level

* "Min. Power" in the figures above and hereinafter refers to the minimum start-up charging power of the EV-Charger, and "Max. Power" refers to the maximum nominal output power of the EV-Charger.

The user can set the charging current level for Green mode on the setting page of the App following the path: **Charger setting > Work mode setting > Green.**

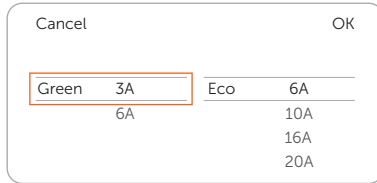

Figure 9-10 Charging current level for Green mode

Eco mode

In Eco mode, the charging power is continuously adjusted according to changes in generation or power consumption elsewhere in the house, thereby minimizing the use of the grid power. In this mode, users can set charging current at five different levels, i.e. 6 A, 10 A, 16 A, 20 A and 25 A (Only 6 A & 10 A for 11 kW models). If at any time, the available surplus power falls below the minimum start-up charging power, such as 1.4 kW for single-phase (4.2 kW for three-phase), the shortfall will be drawn from the grid.

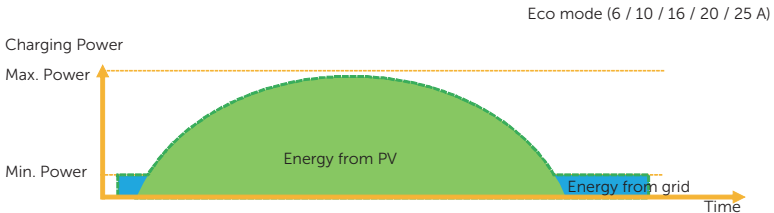

Figure 9-11 Eco mode

The user can set the charging current level for Eco mode on the setting page of the App following the path: **Charger setting > Work mode setting > Eco.**



Figure 9-12 Charging current level for Eco mode

NOTICE!

When the EV-Charger is charging in Green or Eco mode:

- The charging electric vehicle must comply with the IEC61851 standard, otherwise the EV-Charger won't work.
- If there is a zero injection requirement for the system, the EV-Charger must communicate with the inverter in order to charge normally.

Fast mode

In Fast mode, the EV-Charger will charge the EV at the fastest rate regardless of whether the power generated by PV is sufficient and import grid electricity if the power generated by PV is insufficient.

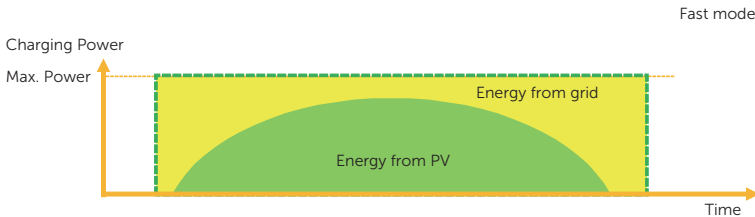

Figure 9-13 Fast mode

The user can do **Schedule Setting** in Fast mode on the control page of the App. Touch **Schedule period** to set the time period.

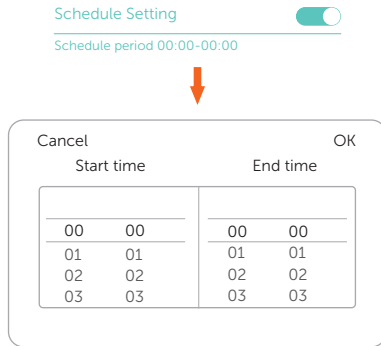

Figure 9-14 Schedule setting

9.5.2 Boost Settings in Home Scene

NOTICE!

- The boost settings will only take effect under Green and Eco modes.
- Smart Boost and Timer Boost cannot take effect at the same time.

Smart Boost

Before using the Smart Boost function, complete the settings as below:

- Enable the **Boost settings** on the control page of the App.
- Touch **Smart Boost**.
- Set the desired **Energy** and **End time** for the vehicle charging, and touch **OK** to confirm.
- Touch the circle to confirm the selection of Smart Boost.

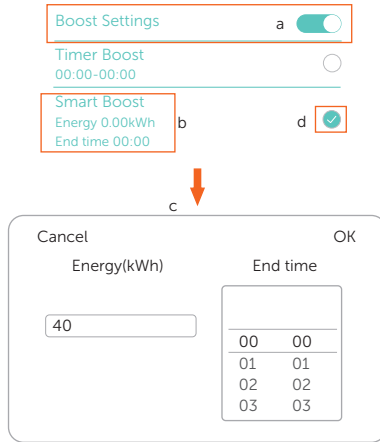

Figure 9-15 Smart Boost setting

The EV-Charger will complete the charging of the EV with desired energy before the preset end time at maximum charging power and will use the photovoltaic power supply as much as possible and minimize the use of the grid power. (E.g.: The user needs to charge the EV to 40 kWh before 10:00 a.m. and complete the settings, the EV-Charger will charge the EV to 40 kWh before 10:00 a.m., after this desired energy and / or the time has reached, the charging power will be depended on the surplus power generated by the inverter if the charging process has not been completed.)

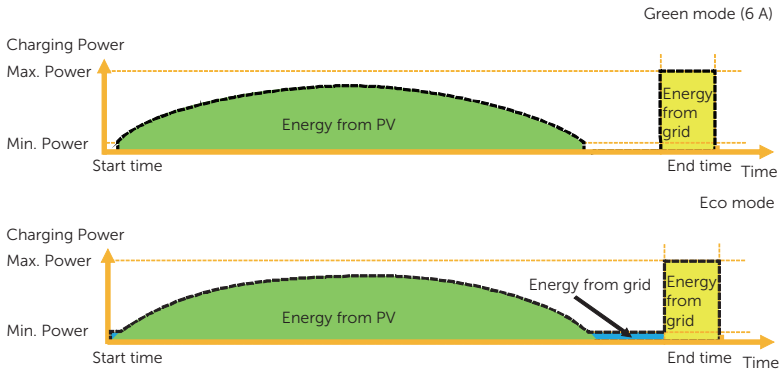

Figure 9-16 Smart Boost

Timer Boost

Before using the Timer Boost function, enable the **Boost settings** on the control page of the App and touch **Timer Boost** and set the desired **Start time** and **End time** for the vehicle charging on the App.

Before using the Timer Boost function, complete the settings as below:

- a. Enable the **Boost settings** on the control page of the App.
- b. Touch **Timer Boost**.
- c. Set the desired **Start time** and **End time** for the vehicle charging, and touch **OK** to confirm.
- d. Touch the circle to confirm the selection of Timer Boost.

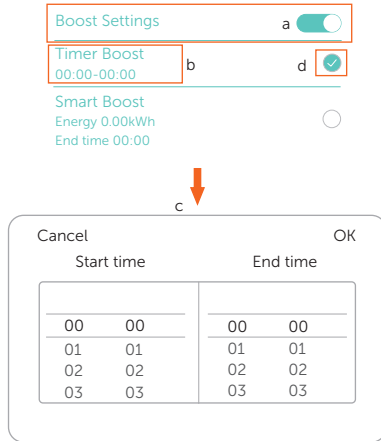

Figure 9-17 Timer Boost setting

When using Eco or Green modes, the EV-Charger can be programmed to "boost" the current charge in a certain period. During the set boost period, the charging rate will adjust to maximum (just like Fast mode), regardless of the amount of available surplus power. This means that the power may be drawn from the mains grid supply during boost times. If the EV is fully charged, the EV-Charger will stop charging.

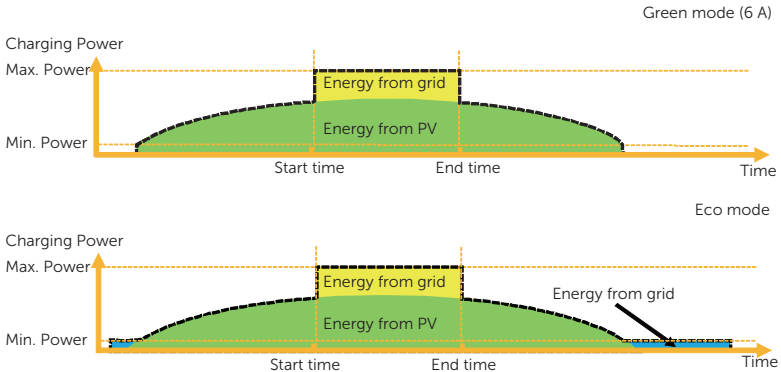

Figure 9-18 Timer Boost

9.5.3 Dynamic Load Balance

The EV-Charger has dynamic load balancing function. During the charging period, no matter in which charging mode, the total power of the house will not exceed the main grid capacity. To ensure the total power of the house doesn't exceed the grid capacity, the charging power will be adjusted in real time following the total load power.

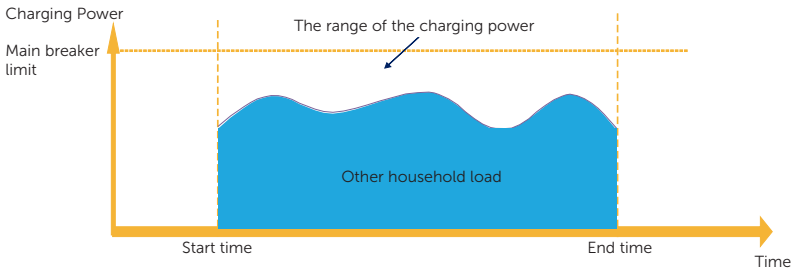

Figure 9-19 Dynamic load balance

If the user wants to use this function, touch **Dynamic load balance** on the setting page following the path: **Charger setting > Dynamic load balance**, enable and set the value for it, then confirm the settings.

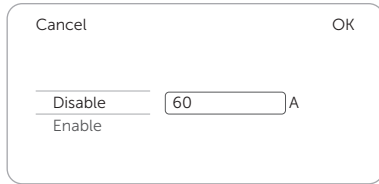

Figure 9-20 Dynamic load balance setting

With the dynamic load balance function, when the power consumption approaches the preset max value, the EV-Charger will reduce charge power so that the main breaker current will reduce to the preset value minus 5 A, thus avoid the situation of main breaker trip due to overload.

9.5.4 Modbus Setting

If the EV-Charger was to communicate with other devices except CT or meter and the user needed to do modbus setting according to the actual application, it could be done on the setting page following the path: **Charger setting > Modbus Setting**.

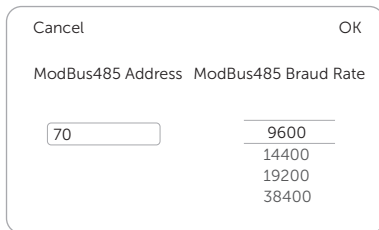

Figure 9-21 Modbus setting

The addresses of different EV-Chargers in the same one system should be different (The default value is 70). The braud rate should be set according to the devices with which the EV-Charging is working (The default value is 9600).

NOTICE!

- The **ModBus485 Address** needs to be modified according to the actual application when multiple EV-Chargers are used in one system and the default value can be kept when one single EV-Charger is used.

9.5.5 Charging Restrict

At most six time periods can be set here, and for each period the user can set its repeat times. At these preset time periods, the EV-Charger will charge at a restricted power limit (**limit**) or will not be available for charging (**ban**).

- a. Touch **Charging restrict** following the path on setting page: **Advanced setting > Charging restrict**.

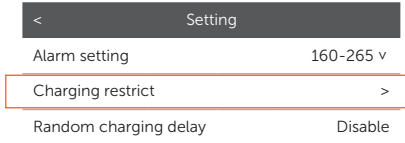

Figure 9-22 Touch Charging restrict

- b. After entering the **Charging Restrict** page, the existed list will appear. The user can choose certain time period(s) and turn on or off the switch as shown, and then touch **Save** to confirm the settings.

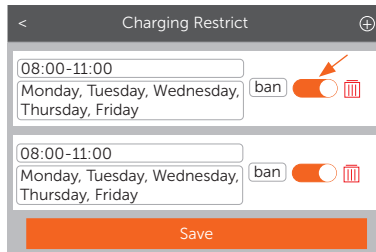

Figure 9-23 Charging restrict list

- c. If the user wants to add a new period, touch the + icon on the upper right and complete relative settings.
- 1) Enable or disable the **Restrictive Activation** for a certain period.
 - 2) Select the **Restrictive Type**. **ban** means charging is not allowed at this period; **limit** means the charging power in this preset time will limit to the preset value.
 - 3) Set the repeat frequency by ticking the days (Multiple choices are possible).
 - 4) Set the **Start time** and **End time** of the period.
 - 5) Touch the tick icon to confirm.

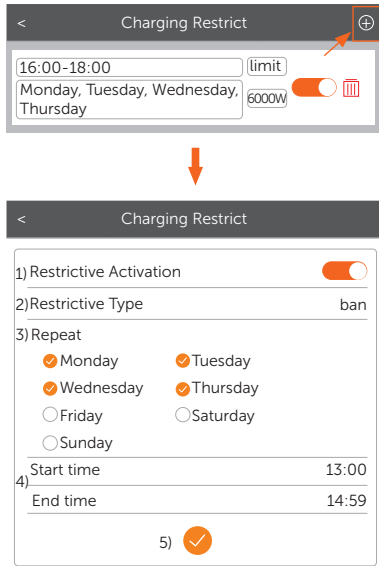

Figure 9-24 Setting a new charging restrict period

- d. If the user wants to revise the settings for a certain period, touch the content box of the period and then update the setting items.

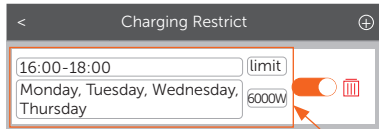

Figure 9-25 Touch to revise

- e. If the user wants to delete a certain period, touch the delete icon and select **OK** in the pop-up window to confirm.

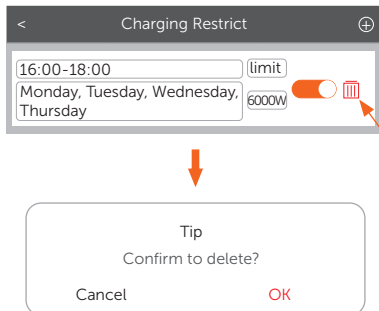

Figure 9-26 Touch to delete

9.5.6 Random Charging Delay

The start charging time for the vehicle can be delayed randomly with the random charging delay function. This function is disabled by default. If needed, the user can enable it following the path on the setting page: **Advanced setting > Random charging delay**. Once enabled, input the charging delay time (s) within a range of 600 s ~ 1800 s.

Figure 9-27 Random charging delay setting

9.5.7 Three Phase Imbalance

This function is only for single-phase EV-Chargers. In some countries, there are some special regulations that the power differences between the phases must not be bigger than 4.6 kW or 3.7 kW. Therefore, when using single-phase EV-Chargers, the charging power must be limited. (This setting item is not available for three-phase EV-Chargers.) If required by local regulations, please enable this function following the path: **Advanced setting > Three phase imbalance** and complete the relative settings:

- 1) Select the correct charge phase after consulting with the technical electrician.
- 2) Set the value for unbalanced power (W) according to local regulations. The default value is 4600.

Figure 9-28 Three phase imbalance setting

NOTICE!

- To achieve the three phase imbalance function, the single-phase EV-Charger should be connected with a three-phase meter or communicate with an inverter. If achieved by communicating with an inverter, the inverter must be connected with a three-phase meter or three-phase CT.

10 Screen Display

NOTICE!

- The screen is optional, only models named with "L" have LCD screen.
- The screen will display the information of the EV-Charger.
- The screen is for display only and not available for setting.

All screen pictures in this section are for illustrative purposes only.

10.1 Description of Icons on the Screen

From the screen, users can get information about the EV-Charger, including its basic information, various connection statuses and charging information or operation tips.

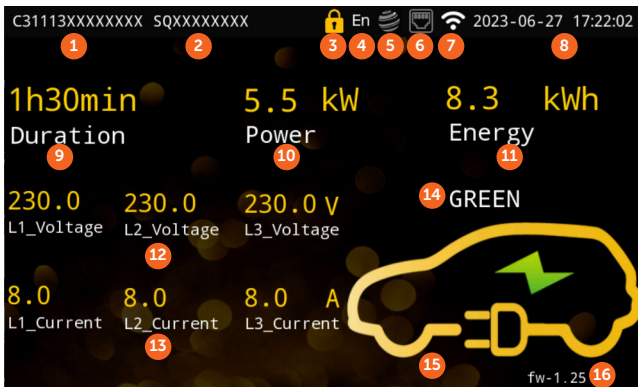

Figure 10-1 Screen display (One example)

Table 10-1 Descriptions of the screen





No.	Item	Description
1	SN	Serial No. of the EV-Charger
2	Registration No.	Registration No. of the EV-Charger
3	Electronic lock status	The electronic lock status of the EV-Charger (only for Socket Type)
4	Language	The language selected for the system (Users can change the language through App settings.)
5	OCPP status	The connection status between the EV-Charger and the OCPP server











No.	Item	Description
6	LAN status	The connection status between the EV-Charger and LAN network
7	WiFi status	The connection status between the EV-Charger and Wi-Fi Router
8	Date & Time	Current date and time
9	Duration	The charging duration of current charging session
10	Charging power	The charging power of current charging session
11	Charging energy	The accumulated charge energy that has been sent to EV in current charging session
12	Voltage	The voltage of the EV-Charger (different phases for three-phase)
13	Charging current	The charging current of the EV-Charger (different phases for three-phase)
14	Charging mode	The charging mode of the EV-Charger (Fast, Green or Eco for Home scene; Charging for OCPP scene)
15	EV connection status	The connection status between the EV-Charger and the EV
16	Firmware version	Firmware version of the EV-Charger

The above example is a screen picture of a three-phase 11 kW Socket Type EV-Charger during the charging process. From 9 to 15 are all about charging information. When the EV-Charger is in different states, the screen will show different information or operation tips. From 1 to 8 (of which 3 is only for Socket Type) and 16 will be displayed in all states to show the basic information and connection status.

Below table explains the icons that may appear on the screen.

Table 10-2 Descriptions of the icons

Item	Icon	Description
Electronic lock status (only for Socket Type)		The electric lock is locked
		The electric lock is unlocked
OCPP status		The EV-Charger has been connected with the OCPP server (Icon in green)
		The EV-Charger is not connected with the OCPP server (Icon in grey)



Item	Icon	Description
LAN status		The EV-Charger has been connected with LAN
		The EV-Charger is not connected with LAN
WiFi status		The EV-Charger has been connected with Wi-Fi (The amounts of the white bars shows the strength of the signal. The more the white bars, the stronger the signal.)
		The EV-Charger is not connected with Wi-Fi
EV connection status		The charging connector is not connected with EV
		The charging connector is connected with EV in but not charging
		Charging
Abnormal status		The EV-Charger is in error state
		The EV-Charger is unavailable
Activation area		Available for card-swiping for Home scene
		QR code for OCPP scene

10.2 Description of Status Screen

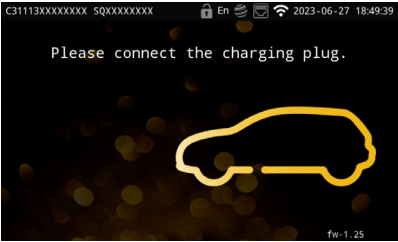

In different states, the screen will display different information or operation tips. Below table gives examples and brief explanations in different states.

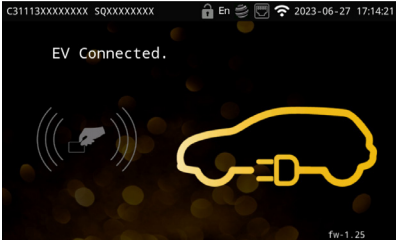
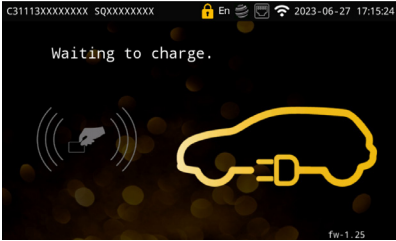
Table 10-3 Descriptions of status screen

Status	Screen Picture	Description
For Home Scene		
Available		The EV-Charger is powered on, but the charging connector is not plugged into the EV.

Status	Screen Picture	Description
Preparing 1		The EV-Charger and the EV are successfully connected. The EV-Charger is to be activated to start charging. Swipe the RFID card to activate the charging session in card-swiping pattern.
Preparing 2		The EV-Charger is waiting for the EV to respond.
Charging		The EV-Charger is charging. The charging information will be displayed. In this example, the EV is charging in Green mode at 5.5 kW, and the EV battery has been charged by 8.3 kWh since the charging session started.
Finishing 1		For Socket Type and in card-swiping or APP activation pattern, when the EV is fully charged, the charging session stops, the electronic lock is still locked, and users need to swipe RFID card to unlock it.

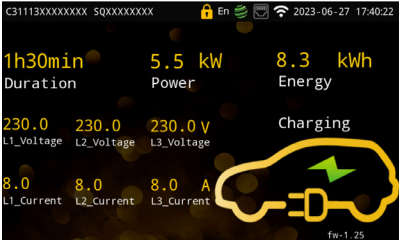
Status	Screen Picture	Description
Finishing 2		<p>The charging session is completed. Swipe the RFID card or start on App, the charging session can be continued. Unplug the charging connector the screen will switch back to Available Status.</p>
For OCPP Scene		
Available		<p>The EV-Charger is powered on, but the charging connector is not plugged into the EV. QR code will be displayed.</p>
Preparing 1		<p>The EV-Charger and the EV are successfully connected. The EV-Charger is to be activated to start charging. Scan the QR code or swipe the card from the OCPP server to activate the charging session.</p>
Preparing 2		<p>The EV-Charger is waiting for the EV to respond.</p>

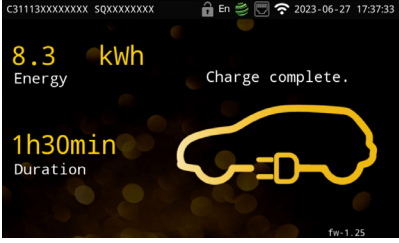
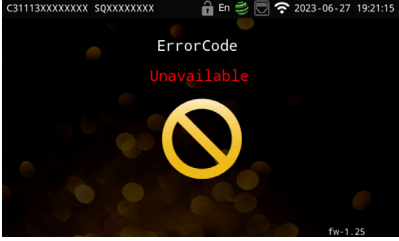
Status	Screen Picture	Description
Charging		The EV-Charger is charging. The charging information will be displayed.
Finishing 1		For Socket Type, when the EV is fully charged, the charging session stops, the electronic lock is still locked, and users need to swipe card to unlock it.
Finishing 2		The charging session is completed.
Unavailable		The EV-Charger is not available for charging.

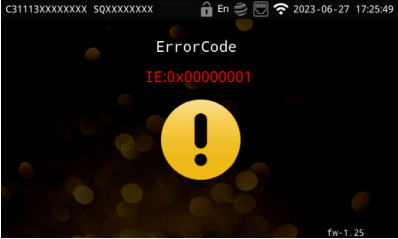
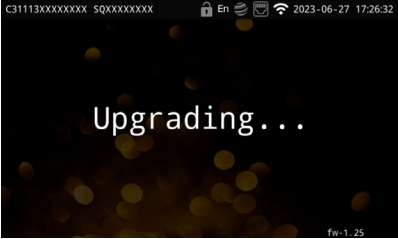
Status	Screen Picture	Description
For Home Scene and OCPP Scene		
Fault		The error code will be displayed when fault occurs. Try the solutions provided in " 11.2 Troubleshooting ", and contact with the service group if necessary.
Upgrade		The EV-Charger is upgrading.

11 Troubleshooting and Maintenance

11.1 Power off

Turn off the RCBO.



- After the EV-Charger powers off, there will still be the remaining electricity and heat which may cause electric shocks and body burns. Please wear personal protective equipment (PPE) and begin servicing the EV-Charger five minutes after power off.

11.2 Troubleshooting

This section contains information and procedures for resolving possible problems with the EV-Charger, and provides the troubleshooting tips to identify and solve most problems that may occur. Please check the warning or fault information on the system control panel or on the App and read the suggested solutions below when error occurs.

Contact SolaX Customer Service for further assistance. Please be prepared to describe the details of your system installation and provide the model and serial number of the EV-Charger.

Table 11-1 Troubleshooting list

Error Code	Fault	Diagnosis and Solutions
IE:0x00000001	EmStop_Fault	Emergency stop fault. <ul style="list-style-type: none">• Release the Emergency button;• Contact installers for help.
IE:0x00000002	OverCurr_Fault	Overcurrent fault. <ul style="list-style-type: none">• Unplug the charging connector from the EV;• If the "Fault" indicator is off, re-plug in and try charging the EV again;• Contact installers for help.
IE:0x00000004	OverTemp_Fault	Temperature beyond limit. <ul style="list-style-type: none">• Unplug the charging connector from the EV;• If the "Fault" indicator is off, re-plug in and try charging the EV again;• If not, confirm that the conditions for installation are proper and waiting for cooling down, then re-plug in and try charging the EV again when the indicator turns off;• Contact installers for help.

Error Code	Fault	Diagnosis and Solutions
IE:0x00000008	PEGround_Fault	<p>PE grounding fault.</p> <ul style="list-style-type: none"> • Unplug the charging connector from the EV; • If the "Fault" indicator is off, check the EV whether it is normal; • If not, confirm that the AC input cable and all its wires are intact; • Contact installers for help.
IE:0x00000010	OverLeakCurr_Fault	<p>6 mA leakage current fault.</p> <ul style="list-style-type: none"> • Unplug the charging connector from the EV; • Power off the EV-Charger and check if the grid status is normal; • After that, power on again and try charging; • Contact installers for help.
IE:0x00000020	PELeakCurr_Fault	<p>PE leakage current fault.</p> <ul style="list-style-type: none"> • Same as Error Code IE:0x00000010.
IE:0x00000040	OverLoad_Fault	<p>Over power fault.</p> <ul style="list-style-type: none"> • Unplug the charging connector from the EV; • If the "Fault" indicator is off, re-plug in and try charging the EV again; • If the "Fault" indicator persists, check the EV whether it is normal; • Contact installers for help.
IE:0x00000100	OverVoltL1_Fault	<p>L1 phase overvoltage fault.</p> <ul style="list-style-type: none"> • Confirm that the grid voltage is within the working range; • If the "Fault" indicator is off, try charging the EV again; • If not, set the value of "Overvoltage Limit" to a proper range, the buzzer will beep after the value is saved; • If the "Fault" indicator is off, try charging the EV again; • Contact installers for help.
IE:0x00000200	UnderVoltL1_Fault	<p>L1 phase undervoltage fault.</p> <ul style="list-style-type: none"> • Confirm that the grid voltage is within the working range; • If the "Fault" indicator is off, try charging the EV again; • If not, set the value of "Undervoltage Limit" to a proper range, the buzzer will beep after the value is saved; • If the "Fault" indicator is off, try charging the EV again; • Contact installers for help.

Error Code	Fault	Diagnosis and Solutions
IE:0x00000400	OverVoltL2_Fault	L2 phase overvoltage fault. <ul style="list-style-type: none"> • Same as Error Code IE:0x00000100
IE:0x00000800	UnderVoltL2_Fault	L2 phase undervoltage fault. <ul style="list-style-type: none"> • Same as Error Code IE:0x00000200
IE:0x00001000	OverVoltL3_Fault	L3 phase overvoltage fault. <ul style="list-style-type: none"> • Same as Error Code IE:0x00000100
IE:0x00002000	UnderVoltL3_Fault	L3 phase undervoltage fault. <ul style="list-style-type: none"> • Same as Error Code IE:0x00000200
IE:0x00004000	MeterCom_Fault	Metering chip communication fault. <ul style="list-style-type: none"> • Power off the EV-Charger and check if the grid status is normal; • After that, power on again and try charging; • Contact installers for help.
IE:0x00008000	485Com_Fault	RS485 communication fault. <ul style="list-style-type: none"> • Check and confirm that the communication cable for RS485 is intact; • Contact installers for help.
IE:0x00010000	PowerSelect_Fault	Power selection fault. <ul style="list-style-type: none"> • Unplug the charging connector from the EV; • Power off the EV-Charger and then power on again and try charging; • Contact installers for help.
IE:0x00020000	CPVolt_Fault	CP voltage fault. <ul style="list-style-type: none"> • Same as Error Code IE:0x00010000.
IE:0x00040000	ElecLock_Fault	Electronic lock fault. <ul style="list-style-type: none"> • Power off the EV-Charger and then power on again; • Contact installers for help.
IE:0x00080000	MeterType_Fault	Meter type fault. <ul style="list-style-type: none"> • Change and install a meter as recommended; • Contact installers for help.
IE:0x00100000	OpenCharger_Fault	EV-Charger tampered alarm. <ul style="list-style-type: none"> • Contact installers for help.
IE:0x00200000	PEN_Fault	PEN fault. <ul style="list-style-type: none"> • Same as Error Code IE:0x00010000.

11.3 Maintenance

Regular maintenance is required for the device. The table of "Proposal of Maintenance" below lists the operational maintenance for expressing the optimum device performance. More frequent maintenance service is needed in the worse work environment. Please make records of the maintenance.

 **WARNING!**

- Only qualified person can perform the maintenance for the EV-Charger.
- Only use the spare parts and accessories approved by SolaX for maintenance.

Table 11-2 Proposal of Maintenance

Item	Check Notes	Maintenance Interval
Safety check	<ul style="list-style-type: none"> • Check if the device is functioning properly. • The safety checks shall be performed by manufacturer’s qualified person who has adequate training, knowledge, and practical experience. 	Every 12 months
EMERGENCY STOP button	Press and release the button for three consecutive times to check if it works normally.	Every 6 months
LED indicators (and LCD screen)	<ul style="list-style-type: none"> • Check if the indicators are in normal state. • Check if the display of the device (if it has a screen) is in normal state. 	Every 6 months
Wiring connections	<ul style="list-style-type: none"> • Check if the cables are securely connected. • Check if the cables are damaged or aged. • Check if the terminals and ports are intact. 	Every 6 months
Grounding reliability	Check if the ground terminal and ground wire are securely connected.	Every 12 months
Housing	Clean and check its security.	Every 6 months

NOTICE!

- When your EV-Charger needs to be upgraded by the service personnel, please make sure to unplug the charging connector from the EV.

12 Decommissioning

12.1 Disassembling the EV-Charger



- When disassembling the EV-Charger, strictly follow the steps as below.
- Use insulated tools and wear individual protective tools when disassembling the EV-Charger.

- Step 1:** Turn off the RCBO to disconnect the EV-Charger from the grid and/or inverter.
- Step 2:** Wait for at least 5 minutes to fully discharge the capacitors inside the EV-Charger.
- Step 3:** Remove the self-tapping screw on the right bottom of the EV-Charger.
- Step 4:** Take down the EV-Charger from the bracket.
- Step 5:** Remove the screws of rear cover and the base plate of communication board. Then pull the base plate of communication board out.
- Step 6:** Disconnect the AC input cable.
- Step 7:** Disconnect the communication cable(s).
- Step 8:** Remove the bracket (and the cable hook) if necessary.

12.2 Packing the EV-Charger

- Load the EV-Charger into the original packing material if possible.
- If the original packing material is not available, you can also use the packing material which meets the following requirements:
 - » Suitable for the weight of product.
 - » Easy to carry
 - » Be capable of being closed completely

12.3 Disposing of the EV-Charger

Please dispose of the EV-Charger or its accessories in accordance with the disposal regulations for electronic waste which is applied at the installation site.

13 Technical Data

- General Data

Models	7.2 kW	11 kW	22 kW
AC Nominal Input			
Phases/Lines	L+N+PE	3P+N+PE	3P+N+PE
Voltage [V]	230	400	400
Frequency [Hz]	50/60; ±5	50/60; ±5	50/60; ±5
AC Nominal Output			
Voltage [V]	230	400	400
Current [A]	32	16	32
Power [W]	7200	11000	22000
Interface			
LAN		Yes	
RS485		Yes	
RFID Frequency [MHz]		13.56	
OCPP 1.6 (JSON)		Yes	
LCD Screen		Optional	
CT Clamps	x1	x3	x3
Housing Material		Plastic/Metal	
Installation Method	Wall-mounted (Optional: pedestal-mounted)		
Wall-mount Bracket		Yes	
Charging Outlet	Socket Type (Socket-outlet) / Plug Type (Charging cable with connector)		
Cable Length [m]		6.5 (for Plug Type)	
Operating Ambient Temperature Range [°C]		-30 to +50 (without screen) / -20 to +50 (with screen)	
Working Humidity		5%~95% without condensation	
Working Altitude [m]		<2000	
Ingress Protection		IP65	
Impact Resistant		IK08	
Protective Class		Class I	
Application Site		Indoor/Outdoor	
Cooling Method		Natural cooling	
Dimension (W*H*D) [mm]	249×370×155 (for Socket Type) / 265×370×155 (for Plug Type)		
Net Weight [kg]	5.5 for Socket Type, 8 for Plug Type	6 for Socket Type, 8 for Plug Type	6 for Socket Type, 9.5 for Plug Type

Models	7.2 kW	11 kW	22 kW
Communication Info			
Communication Mode 1	WiFi		
EIRP Power	17.41 dBm (Measured Max. Average)		
Frequency	2412~2484 MHz		
Antenna Gain	4 dBi		
Antenna Type	IPEX		
Wireless Mode	802.11 b/g/n		
Communication Mode 2	LAN		
Ethernet	10/100 M (DHCP)		

• Security & Protection



Models	7.2 kW	11 kW	22 kW
Multiple Protection			
Over/Under voltage protection	Yes		
Overload protection	Yes		
Current leakage monitoring	Integrated current failure monitoring (30 mA AC & 6 mA DC) *		
Grounding protection	Yes		
Surge protection	Yes		
Over temperature protection	Yes		
Safety Standard	IEC61851-1; IEC62196-2		
Built-in PEN Fault Technology **	According to BS 7671:2018 requirements		
Warranty	3 years		

* This document does not replace any regional, state, provincial or national laws, regulations or standards that apply to the installation, electrical safety and use of the product. Always observe the local regulations as well.



** Only for models named with "-P".

Contact Information



UNITED KINGDOM

 Unit 10, Eastboro Fields, Hemdale Business Park, Nuneaton, CV11 6GL
 +44 (0) 2476 586 998
 service.uk@solaxpower.com

TURKEY

 Esenşehir Mah. Hale Sk. No:6/1 Ümraniye / İSTANBUL
 +90 (216) 622 58 00 (pbx)
 service.eu@solaxpower.com



USA

 3780 Kilroy Airport Way, Suite 200, Long Beach, CA, US 90806
 +1 (408) 690 9464
 info@solaxpower.com



POLAND

 WARSAW AL. JANA P. II 27. POST
 +48 662 430 292
 service.pl@solaxpower.com



ITALY

 +39 348 2786 409
 support.it@solaxpower.com





AUSTRALIA

 12-18 Lascelles St, Springvale VIC 3171
 +61 1300 476 529
 service@solaxpower.com



GERMANY

 Eisenstraße 3, 65428 Rüsselsheim am Main, Germany
 +49 (0) 6142 4091 664
 service.eu@solaxpower.com



NETHERLANDS

 Twekkeler-Es 15 7547 ST Enschede
 +31 (0) 8527 37932
 service.eu@solaxpower.com
 service.bnl@solaxpower.com

SPAIN

 +34 9373 79607
 tecnico@solaxpower.com

BRAZIL

 +55 (34) 9667 0319
 info@solaxpower.com



SolaX Power Network Technology (Zhejiang) Co., Ltd.

Add.: No. 288, Shizhu Road, Tonglu Economic Development Zone,
Tonglu City, Zhejiang Province, 310000 P. R. CHINA

Tel.: +86 (0) 571-56260011

E-mail: info@solaxpower.com / service@solaxpower.com

